



Flexitallic®

YOUR GLOBAL GASKET PROVIDER



***SPIRAL WOUND
GASKETS***

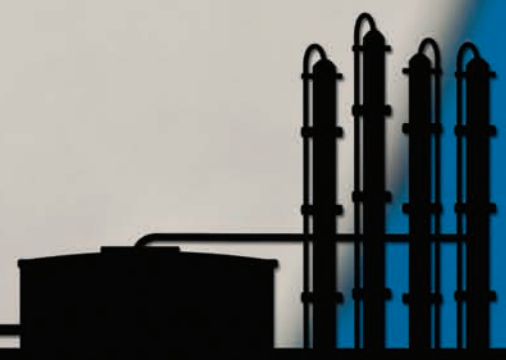



YOUR GLOBAL GASKET PROVIDER
FLEXITALLIC, A WORLDWIDE ORGANIZATION

LOCAL SERVICE
COMMITTED TO MEETING CUSTOMER NEEDS

COMPREHENSIVE PRODUCT RANGE
FOR ALL MAJOR INDUSTRIAL SEALING APPLICATIONS

SEALING SOLUTIONS
THE ANSWER IS ALWAYS FLEXITALLIC

	Page
CONTENTS	
MANUFACTURING UNITS	2
INTRODUCTION	3
GASKET IDENTIFICATION	4
AVAILABLE GASKET MATERIALS	5
GASKET SELECTION	6
DIMENSIONAL DATA	7
TABLE 1 - STYLE CG & CGI TO ASME B16.20 TO SUIT ASME B16.5 FLG - IMPERIAL SIZES	8
TABLE 2 - STYLE CG & CGI TO ASME B16.20 TO SUIT ASME B16.5 FLG - METRIC SIZES	9
TABLE 3 - INNER RING DIMENSIONS FOR STYLE CGI TO ASME B16.20	10
TABLE 4 - STYLE CG & CGI TO SUIT SMALL DIA SCREWED OR SLIP-ON FLG	10
TABLE 5 - MAXIMUM BORE OF ASME B16.5 FLG	11
TABLE 6 - STYLE CG & CGI TO ASME B16.20 TO SUIT LARGE DIA ASME B16.47 SERIES B FLG - IMPERIAL SIZES	12
TABLE 7 - STYLE CG & CGI TO ASME B16.20 TO SUIT LARGE DIA ASME B16.47 SERIES B FLG - METRIC SIZES	14
TABLE 7 - STYLE CG & CGI TO ASME B16.20 TO SUIT LARGE DIA ASME B16.47 SERIES A AND BS 3293 FLG	15
TABLE 8 - STYLE CG & CGI TO SUIT LARGE DIA FLG - IMPERIAL SIZES	16
TABLE 9 - STYLE CG & CGI TO SUIT LARGE DIA FLG - METRIC SIZES	18
TABLE 10 - STYLE CG & CGI TO SUIT LARGE DIA FLG	20
TABLE 11 - STYLE CG & CGI TO BS 3381 TO SUIT BS 1560 & ASME B16.5 FLG - IMPERIAL SIZES	22
TABLE 12 - STYLE CG & CGI TO BS 3381 TO SUIT BS 1560 & ASME B16.5 FLG - METRIC SIZES	23
TABLE 13 - STYLE CG & CGI TO SUIT BS 10 FLG	24
TABLE 14 - STYLE CG & CGI TO BS 4865 PART 2 TO SUIT BS 4504 FLG	25
TABLE 15 - STYLE CG & CGI TO SUIT DIN FLANGES	26
TABLE 16 - STYLE R TO SUIT ASME B16.5 AND BS 1560 FLG	27
TABLE 17 - STYLE RIR TO SUIT ASME B16.5 AND BS 1560 FLG	28
TABLE 18 - STYLE CG & CGI TO SUIT JIS FLG	29
TABLE 19 - STYLE CG & CGI TO SUIT JIS FLG	29
TABLE 20 - STYLE CG-RJ & CGI-RJ REPLACEMENTS FOR RING JOINT GASKETS	30
TABLE 21 - STYLE 625 FOR CLAMP-TYPE AND OTHER NON-STANDARD FLANGE ASSEMBLIES	31
USEFUL TECHNICAL DATA	32
ASSEMBLY TECHNIQUES	32
TABLE 22 - RECOMMENDED TORQUE CG SPIRAL WOUND GASKETS	33
TABLE 23 - RECOMMENDED TORQUE CGI SPIRAL WOUND GASKETS	34
TABLE 24 - BOLTING DATA FOR ASME B16.5 AND BS 1560 FLG	35
TABLE 25 - FACING DIMENSIONS FOR ASME B16.5 AND BS 1560 FLG	36
SPECIAL APPLICATION GASKETS	37
SPECIAL CGI WITH SPIRAL WOUND OUTER RING GASKETS FOR HEAT EXCHANGERS	37
CARRIER RING GASKETS	38
STYLE LS & LSI LOW STRESS GASKETS	39
BOILER CAP AND MANHOLE COVER GASKETS	40
TABLE 26 - STYLE M, MC & MCS	41
TABLE 27 - STYLE T	42
THERMICULITE 835 HEAT TREATED INCONEL X-750 SPIRAL WOUND GASKETS	43
MULTI-CLASS SPIRAL WOUND GASKETS	44
BAKER GASKETS	45

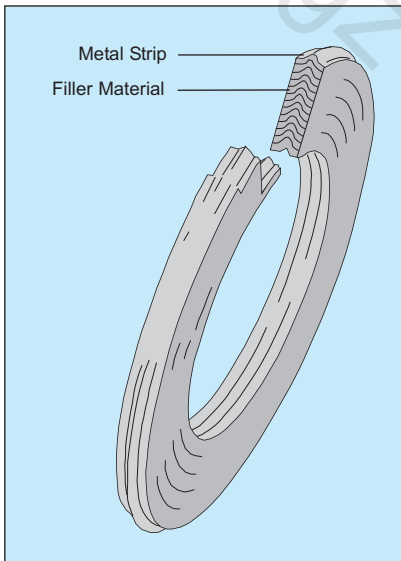

INTRODUCTION

FIRST AND FOREMOST

The concept of spiral wound gasket construction was originated by Flexitallic in 1912, inaugurating the beginning of a new era in safe, effective sealing. The primary purpose for this development was the increasingly severe temperatures and pressures used by U.S. refinery operators in the first half of the century.

The necessity for a gasket to have the ability to recover cannot be over emphasized. The effects of pressure and temperature fluctuations, the temperature differential across the flange face, together with bolt stress relaxation and creep, demand a gasket with adequate flexibility and recovery to maintain a seal even under these varying service conditions. The Flexitallic Spiral Wound Gasket is the precision engineered solution to such problems, meeting the most exacting conditions of both temperature and pressure in flanged joints and similar assemblies and against virtually every known corrosive and toxic media.

This publication is designed to facilitate the specification and ordering of standard Flexitallic Spiral Wound Gaskets. Dimensional data for the basic styles - Style CG, Style CGI, Style R and Style RIR are detailed on respective tables.

GASKET IDENTIFICATION

Gaskets are color coded to help expedite the selection and identity of the gaskets you need. The color on the outside edge of the centering ring identifies both the winding and filler materials. The metallic winding material is designated by a solid color. The filler materials are designated by color stripes at equal intervals on the outside edge of the centering ring. Flexitallic color coding meets the industry standard for metal and filler materials listed in ASME B16.20.

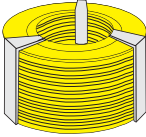
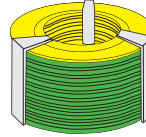
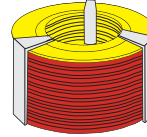
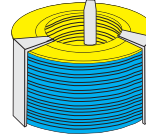
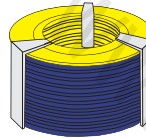
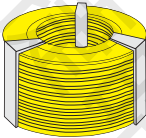
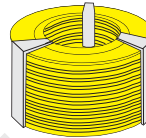
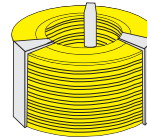
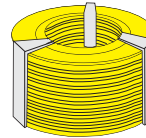
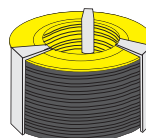
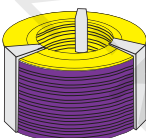
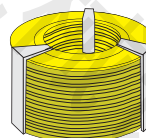
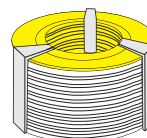
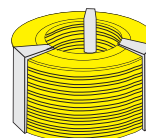
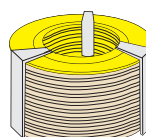
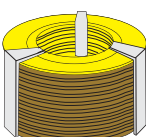
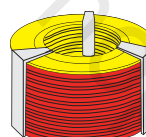
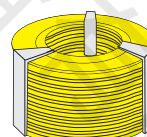
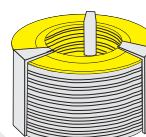
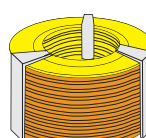
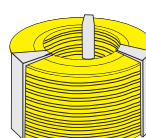
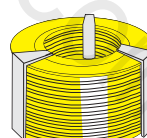
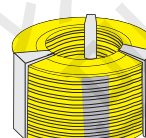
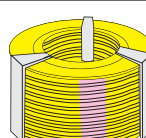
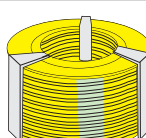
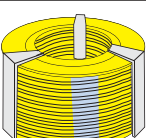
<p>METALLIC WINDING MATERIALS The metallic winding material is designated by a solid color identification around the outside edge of the centering ring.</p>	 <p>304SS Yellow</p>	 <p>316LSS Green</p>	 <p>317L Maroon</p>	 <p>321SS Turquoise</p>
 <p>347SS Blue</p>	 <p>310SS No color</p>	 <p>304LSS No color</p>	 <p>309SS No color</p>	 <p>430SS No color</p>
 <p>Alloy 20 Black</p>	 <p>Titanium® Purple</p>	 <p>Inconel® 600/625 Gold</p>	 <p>Incoloy® 800/825 White</p>	 <p>Inconel® X750 No Color</p>
 <p>Hastelloy® C276 Beige</p>	 <p>Hastelloy® B2 Brown</p>	 <p>Nickel 200 Red</p>	 <p>Zirconium No color</p>	 <p>Carbon Steel Silver</p>
 <p>Monel® Orange</p>	 <p>Duplex No color</p>	<p>NON METALLIC FILLERS The gasket filler materials are designated by a number of stripes placed at equal intervals around the outside edge of the centering ring.</p>	 <p>PTFE White Stripe</p>	 <p>Flexicarb® Gray Stripe</p>
 <p>Flexite Super® Pink Stripe</p>	 <p>Ceramic Light Green Stripe</p>	 <p>Thermiclite® 835 Light Blue Stripe</p>		

AVAILABLE GASKET MATERIALS

METAL WINDING STRIP AS STANDARD	FILLER MATERIAL	GUIDE RING MATERIAL AS STANDARD
Stainless Steel type 304 316L	Flexicarb® flexible graphite Thermiculite® 835 Flexite Super® PTFE Mica Ceramic Non-sintered PTFE	Carbon Steel
OTHERS Stainless Steel type 304L 309 310 316Ti 317L 321 347 430 17-7PH	Thermiculite®, FLEXITALLIC'S proprietary high-temperature, sealing material is comprised of chemically exfoliated and thermally exfoliated vermiculite. This revolutionary patented product simulates the structure of exfoliated graphite but with one notable exception ... gaskets made with Thermiculite® maintain their integrity, even at extreme temperatures. Thermiculite is thermally stable, ensuring against thermal oxidation, at temperatures in excess of 1800°F (Thermiculite® 835).	OTHERS Stainless Steel type 304 304L 316 316L 316Ti 310 321 347 410 430
ALLOY 20 MONEL® TITANIUM® NICKEL® 200 INCONEL® type 600 625 X-750		INCONEL® 600 625
HASTELLOY® type B2 C276		MONEL® TITANIUM® NICKEL INCOLOY® type 800 825
INCOLOY® type 800 825		ALLOY 20 HASTELLOY® type B-2 C276
DUPLEX ZIRCONIUM® TANTALUM® COPPER PHOS-BRONZE		

NOTES:

Selected materials should be compatible with operating temperature and chemicals. If in doubt, contact Flexitallic Technical Department.

If PTFE is subjected to temperatures above 250°C (500°F) decomposition starts to occur slowly, increasing rapidly above 400°C (750°F). Care should be taken to avoid inhaling the resultant fumes, which may produce hazardous effects.

IDENTIFICATION REQUIREMENTS

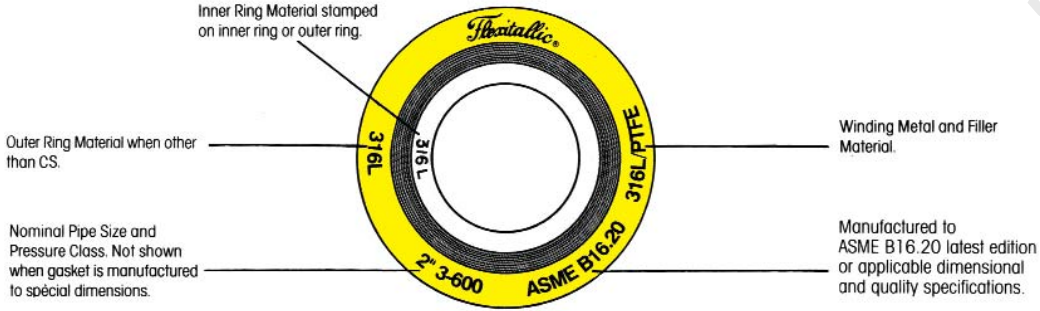

GASKET SELECTION

WHAT STYLE OF GASKET SHOULD I SELECT?

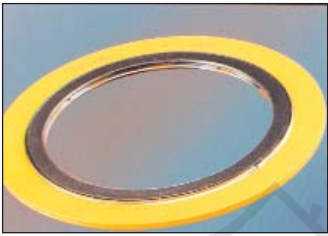

Style CG - Utilizes an external ring which accurately centers gasket on flange face, provides additional radial strength to prevent gasket blow-out and acts as a compression stop. A general purpose gasket suitable for use with flat face and raised face flanges up to and inclusive of class 2500. See note at bottom of page 8 for inner ring requirements.



Style CGI - A Style CG gasket fitted with internal ring which gives an additional compression limiting stop and provides heat and corrosion barrier protecting gasket windings and preventing flange erosion. Suitable for use with flat face and raised face flanges. See note at bottom of page 8 for inner ring requirements.



Style R - Basic construction type. Inner and outer diameters are reinforced with several plies of metal without filler to give greater stability and better compression and sealing characteristics. Suitable for tongue and groove and groove or male and female or grooved to flat face flange assemblies.

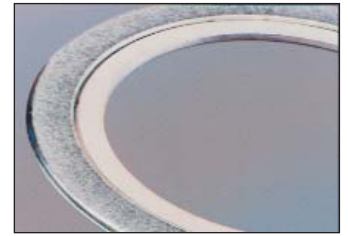

Style RIR - Solid inner metal ring acts as a compression stop and fills the annular space between flange bore and the inside diameter of the gasket. Designed to prevent accumulation of solids, reduce turbulent flow of process fluids and minimize erosion at flange faces. Suitable for male and female pipe flanges.

SELECTION GUIDE

Published as an indication of which Flexitallic spiral wound gasket best suits different pipe flange configurations and service conditions.

Flange Face					
Recommended Gasket Style For general duties	 Style CG	 Style CG	 Style R*	 Style R*	 Style R*
Recommended Gasket Style For high pressure/temperature duty, also for gaskets with PTFE filler, corrosive or fluctuating pressure or temperature service conditions.	 Style CGI**	 Style CGI**	 Style RIR**	 Style RIR**	 Style RIR**

*It is essential that Style R gaskets are fitted with a compression stop. Without a correctly dimensioned stop the gasket can easily be over-compressed resulting in failure. To provide a compression stop the depth of the tongue, groove or recess should be controlled to provide optimum compressed gasket thickness with metal to metal contact on the flange faces (see tables on Page 28 and 32).

** See note at bottom of page 8 for inner ring requirements.

DIMENSIONAL DATA

STYLE CG & CGI GASKETS TO SUIT STANDARD RAISED FACE AND FLAT FACE FLANGES

SPECIAL GASKETS

Gaskets of special design can be engineered and fabricated using the same basic fundamentals of Flexitallic Spiral Wound Gasket design and construction to cover a wide range of applications in installations for which there are no industry-wide standards. Special gaskets have been designed for valves, pumps, compressors, turbines, boilers, heat exchangers, etc. Consult with Flexitallic engineers as early in the design stage as possible.

GOVERNMENT SPECIFICATIONS

Flexitallic Spiral Wound Gaskets are available in accordance with Military Specifications MIL-G-24716, and MIL-G-15342, latest revisions. When making an inquiry, refer to the proper Government Specification number.

*Style CG

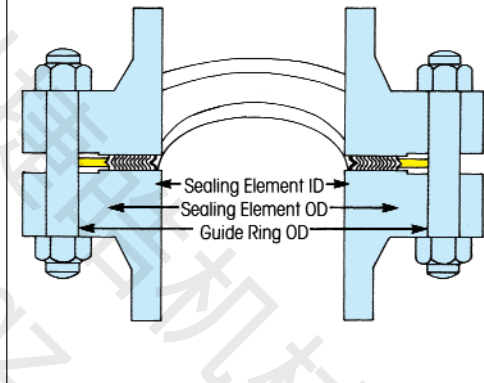

*Style CGI

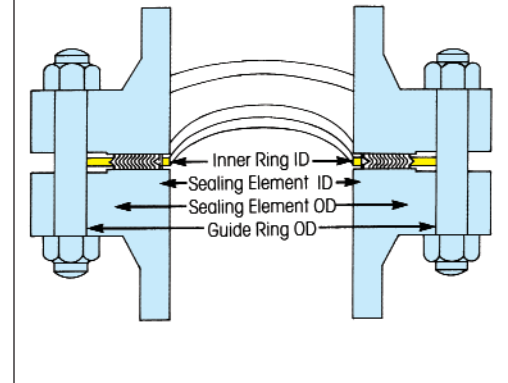

All CG and CGI Gaskets for these standard flanges are 0.175 in (4.5mm) thick, fitted with 0.125 in (3.2mm) thick solid metal rings, unless otherwise stated.

Flexitallic style CG and CGI Spiral Wound gaskets can be manufactured in accordance with all relevant gasket standards to suit the following flange designations.

Please note that gaskets for non-standard flanges are also readily available.

ASME B16.5
BS 1560
BS 10
ASME B16.47 SERIES B (API 605)
ASME B16.47 SERIES A (MSS SP 44)
BS 4504
DIN FLANGES
JIS FLANGES

WHEN ORDERING PLEASE SPECIFY	EXAMPLE
GASKET STYLE	FLEXITALLIC STYLE "CGI" SPIRAL WOUND GASKET
NOMINAL PIPE SIZE (NPS)	4"
PRESSURE RATING	CLASS 900
GASKET STANDARD	ASME B16.20
WINDING MATERIALS	316L/FLEXICARB (FG)
OUTER RING MATERIAL	CARBON STEEL
INNER RING MATERIAL	316L

Note: Please select correct gasket style for your particular application. See page 6 "Gasket Selection".

STYLE CG & CGI* TO ASME B16.20 TO SUIT ASME B16.5 FLANGES

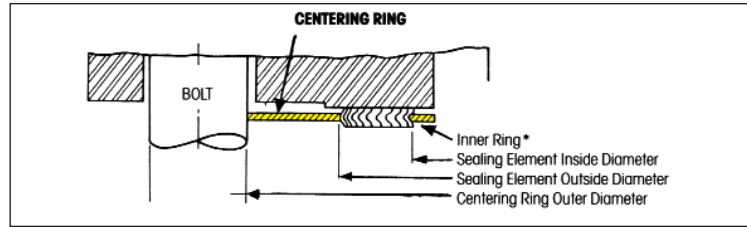
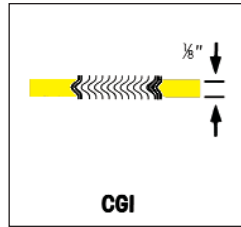
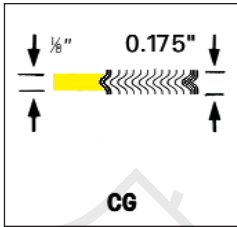

TABLE
1

NOM PIPE SIZE	OUTSIDE DIAMETER OF SEALING ELEMENT		INNER DIAMETER OF SEALING ELEMENT							OUTER DIAMETER OF CENTERING RING						
	CLASS 150, 300, 400, 600	CLASS 900, 1500, 2500	CLASS 150	CLASS 300	CLASS 400	CLASS 600	CLASS 900	CLASS 1500	CLASS 2500	CLASS 150	CLASS 300	CLASS 400	CLASS 600	CLASS 900	CLASS 1500	CLASS 2500
1/4	7/8	-	1/2	1/2	1/2	1/2	-	-	-	1-3/4	1-3/4	1-3/4	1-3/4	-	-	-
1/2	1-1/4	1-1/4	3/4	3/4	3/4	3/4	3/4	3/4	3/4	1-7/8	2-1/8	2-1/8	2-1/8	2-1/2	2-1/2	2-3/4
3/4	1-9/16	1-9/16	1	1	1	1	1	1	1	2-1/4	2-5/8	2-5/8	2-5/8	2-3/4	2-3/4	3
1	1-7/8	1-7/8	1-1/4	1-1/4	1-1/4	1-1/4	1-1/4	1-1/4	1-1/4	2-5/8	2-7/8	2-7/8	2-7/8	3-1/8	3-1/8	3-3/8
1-1/4	2-3/8	2-3/8	1-7/8	1-7/8	1-7/8	1-7/8	1-9/16	1-9/16	1-9/16	3	3-1/4	3-1/4	3-1/4	3-1/2	3-1/2	4-1/8
1-1/2	2-3/4	2-3/4	2-1/8	2-1/8	2-1/8	2-1/8	1-7/8	1-7/8	1-7/8	3-3/8	3-3/4	3-3/4	3-3/4	3-7/8	3-7/8	4-5/8
2	3-3/8	3-3/8	2-3/4	2-3/4	2-3/4	2-3/4	2-5/16	2-5/16	2-5/16	4-1/8	4-3/8	4-3/8	4-3/8	5-5/8	5-5/8	5-3/4
2-1/2	3-7/8	3-7/8	3-1/4	3-1/4	3-1/4	3-1/4	2-3/4	2-3/4	2-3/4	4-7/8	5-1/8	5-1/8	5-1/8	6-1/2	6-1/2	6-5/8
3	4-3/4	4-3/4	4	4	4	4	3-3/4	3-5/8	3-5/8	5-3/8	5-7/8	5-7/8	5-7/8	6-5/8	6-7/8	7-3/4
3-1/2	5-1/4	5-1/4	4-1/2	4-1/2	4-1/8	4-1/8	4-1/8	4-1/8	-	6-3/8	6-1/2	6-1/2	6-3/8	7-1/2	7-3/8	-
4	5-7/8	5-7/8	5	5	4-3/4	4-3/4	4-3/4	4-5/8	4-5/8	6-7/8	7-1/8	7	7-5/8	8-1/8	8-1/4	9-1/4
4-1/2	6-1/2	6-1/2	5-1/2	5-1/2	5-5/16	5-5/16	5-5/16	5-5/16	-	7	7-3/4	7-7/8	8-1/4	9-3/8	9-1/8	-
5	7	7	6-1/8	6-1/8	5-13/16	5-13/16	5-13/16	5-5/8	5-5/8	7-3/4	8-1/2	8-7/8	9-1/2	9-3/4	10	-
6	8-1/4	8-1/4	7-3/16	7-3/16	6-7/8	6-7/8	6-7/8	6-3/4	6-3/4	8-3/4	9-7/8	9-7/8	10-1/2	11-3/8	11-1/8	12-1/2
8	10-3/8	10-1/8	9-3/16	9-3/16	8-7/8	8-7/8	8-3/4	8-1/2	8-1/2	11	12-1/8	12	12-5/8	14-1/8	13-7/8	15-1/4
10	12-1/2	12-1/4	11-5/16	11-5/16	10-13/16	10-13/16	10-7/8	10-1/2	10-5/8	13-3/8	14-1/4	14-7/8	15-3/4	17-1/8	17-1/8	18-3/4
12	14-3/4	14-1/2	13-3/8	13-3/8	12-7/8	12-7/8	12-3/4	12-3/4	12-1/2	16-1/8	16-5/8	16-1/2	18	19-5/8	20-1/2	21-5/8
14	16	15-3/4	14-5/8	14-5/8	14-1/4	14-1/4	14	14-1/4	-	17-3/4	19-1/8	19	19-3/8	20-1/2	22-3/4	-
16	18-1/4	18	16-5/8	16-5/8	16-1/4	16-1/4	16-1/4	16	-	20-1/4	21-1/4	21-7/8	22-1/4	22-5/8	25-1/4	-
18	20-3/4	20-1/2	18-11/16	18-11/16	18-1/2	18-1/2	18-1/4	18-1/4	-	21-5/8	23-1/2	23-7/8	24-1/8	25-1/8	27-3/4	-
20	22-3/4	22-1/2	20-11/16	20-11/16	20-1/2	20-1/2	20-1/2	20-1/4	-	23-7/8	25-3/4	25-1/2	26-7/8	27-1/2	29-3/4	-
24	27	26 3/4	24 3/4	24 3/4	24-3/4	24-3/4	24-3/4	24-1/4	-	28-1/4	30-1/2	30-1/4	31-1/8	33	35-1/2	-

DIMENSIONS IN INCHES.

*For Style CGI - see Table 3 for Inner Ring dimensions

Gasket sizes 1/4" to 3" Class 300, 400 & 600 as well as sizes 1/2" to 2-1/2" Class 900 & 1500 are identical within their respective nominal pipe sizes, therefore inventories need not be duplicated.

In accordance with ASME B16.20, Inner Rings are mandatory for the following flange designations (see Table 3).

Class 900 - NPS 24 to 48

Class 1500 - NPS 12 to NPS 24

Class 2500 - NPS 4 to NPS 12

All PTFE filled gaskets

All flexible graphite gaskets unless otherwise requested by the customer

ASME B16.20 does not include dimensions for NPS 1/4, 3-1/2, or 4-1/2, or Class 400 Flanges up to NPS 3 and Class 900 Flanges up to NPS 2-1/2.

STYLE CG & CGI* TO ASME B16.20 TO SUIT ASME B16.5 FLANGES

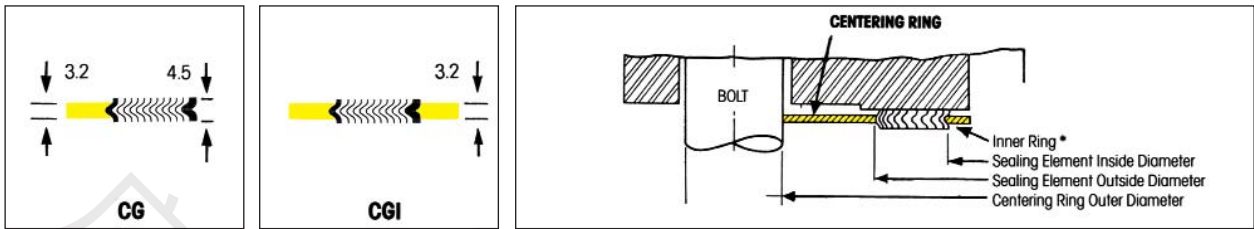

TABLE
2

NOM PIPE SIZE	OUTSIDE DIAMETER OF SEALING ELEMENT		INNER DIAMETER OF SEALING ELEMENT							OUTER DIAMETER OF CENTERING RING						
	CLASS 150, 300, 400, 600	CLASS 900, 1500, 2500	CLASS 150	CLASS 300	CLASS 400	CLASS 600	CLASS 900	CLASS 1500	CLASS 2500	CLASS 150	CLASS 300	CLASS 400	CLASS 600	CLASS 900	CLASS 1500	CLASS 2500
1/4	22.2	-	12.7	12.7	12.7	12.7	-	-	-	44.5	44.5	44.5	44.5	-	-	-
1/2	31.8	31.8	19.1	19.1	19.1	19.1	19.1	19.1	19.1	47.8	54.1	54.1	54.1	63.5	63.5	69.9
3/4	39.6	39.6	25.4	25.4	25.4	25.4	25.4	25.4	25.4	57.2	66.8	66.8	66.8	69.9	69.9	76.2
1	47.8	47.8	31.8	31.8	31.8	31.8	31.8	31.8	31.8	66.8	73.2	73.2	73.2	79.5	79.5	85.9
1-1/4	60.5	60.5	47.8	47.8	47.8	47.8	39.6	39.6	39.6	76.2	82.6	82.6	82.6	88.9	88.9	104.9
1-1/2	69.9	69.9	54.1	54.1	54.1	54.1	47.8	47.8	47.8	85.9	95.3	95.3	95.3	98.6	98.6	117.6
2	85.9	85.9	69.9	69.9	69.9	69.9	58.7	58.7	58.7	104.9	111.3	111.3	111.3	143.0	143.0	146.1
2-1/2	98.6	98.6	82.6	82.6	82.6	82.6	69.9	69.9	69.9	124.0	130.3	130.3	130.3	165.1	165.1	168.4
3	120.7	120.7	101.6	101.6	101.6	101.6	95.3	92.2	92.2	136.7	149.4	149.4	149.4	168.4	174.8	196.9
3-1/2	133.4	133.4	114.3	114.3	104.8	104.8	104.8	104.8	-	161.9	165.1	161.9	161.9	190.5	187.3	-
4	149.4	149.4	127.0	127.0	120.7	120.7	120.7	117.6	117.6	174.8	181.1	177.8	193.8	206.5	209.6	235.0
4-1/2	165.1	165.1	139.7	139.7	134.9	134.9	134.9	134.9	-	177.8	196.9	193.7	209.6	238.1	231.8	-
5	177.8	177.8	155.7	155.7	147.6	147.6	147.6	143.0	143.0	196.9	215.9	212.9	241.3	247.7	254.0	279.4
6	209.6	209.6	182.6	182.6	174.8	174.8	174.8	171.5	171.5	222.3	251.0	247.7	266.7	289.1	282.7	317.5
8	263.7	257.3	233.4	233.4	225.6	225.6	222.3	215.9	215.9	279.4	308.1	304.8	320.8	358.9	352.6	387.4
10	317.5	311.2	287.3	287.3	274.6	274.6	276.4	266.7	270.0	339.9	362.0	358.9	400.1	435.1	435.1	476.3
12	374.7	368.3	339.9	339.9	327.2	327.2	323.9	323.9	317.5	409.7	422.4	419.1	457.2	498.6	520.7	549.4
14	406.4	400.1	371.6	371.6	362.0	362.0	355.6	362.0	-	450.9	485.9	482.6	492.3	520.7	577.9	-
16	463.6	457.2	422.4	422.4	412.8	412.8	412.8	406.4	-	514.4	539.8	536.7	565.2	574.8	641.4	-
18	527.1	520.7	474.7	474.7	469.9	469.9	463.6	463.6	-	549.4	596.9	593.9	612.9	638.3	704.9	-
20	577.9	571.5	525.5	525.5	520.7	520.7	520.7	514.4	-	606.6	654.1	647.7	682.8	698.5	755.7	-
24	685.8	679.5	628.7	628.7	628.7	628.7	628.7	616.0	-	717.6	774.7	768.4	790.7	838.2	901.7	-

DIMENSIONS IN MILLIMETERS.

*For Style CGI - see Table 3 for Inner Ring dimensions.

Gasket sizes 1/4" to 3" Class 300, 400 & 600 as well as sizes 1/2" to 2-1/2" Class 900 & 1500 are identical within their respective nominal pipe sizes, therefore inventories need not be duplicated.

In accordance with ASME B16.20, Inner Rings are mandatory for the following flange designations (see Table 3).

- Class 900 - NPS 24 to 48
- Class 1500 - NPS 12 to NPS 24
- Class 2500 - NPS 4 to NPS 12
- All PTFE filled gaskets
- All flexible graphite gaskets unless otherwise requested by the customer

ASME B16.20 does not include dimensions for NPS 1/4, 3-1/2, or 4-1/2, or Class 400 Flanges up to NPS 3 and Class 900 Flanges up to NPS 2-1/2.

STANDARD INSIDE DIAMETERS OF INNER RINGS FOR STYLE CGI GASKETS TO ASME B16.20 TO SUIT ASME B16.5 FLANGES

See Table 4 for small diameter screwed and slip-on flanges.

TABLE 3

NON PIPE SIZE	PRESSURE CLASS													
	150		300		400		600		900		1500		2500	
1/2	0.56	14.22	0.56	14.22	0.56	14.22	0.56	14.22	0.56	14.22	0.56	14.22	0.56	14.22
3/4	0.81	20.57	0.81	20.57	0.81	20.57	0.81	20.57	0.81	20.57	0.81	20.57	0.81	20.57
1	1.06	26.92	1.06	26.92	1.06	26.92	1.06	26.92	1.06	26.92	1.06	26.92	1.06	26.92
1-1/4	1.50	38.10	1.50	38.10	1.50	38.10	1.50	38.10	1.31	33.27	1.31	33.27	1.31	33.27
1-1/2	1.75	44.45	1.75	44.45	1.75	44.45	1.75	44.45	1.63	41.40	1.63	41.40	1.63	41.40
2	2.19	55.63	2.19	55.63	2.19	55.63	2.19	55.63	2.06	52.32	2.06	52.32	2.06	52.52
2-1/2	2.62	66.55	2.62	66.55	2.62	66.55	2.62	66.55	2.50	63.60	2.50	63.50	2.50	63.50
3	3.19	81.03	3.19	81.03	3.19	81.03	3.19	81.03	3.10	78.74	3.10	78.74	3.10	78.74
4	4.19	106.43	4.19	106.43	4.04	102.62	4.04	102.62	4.04	102.62	3.85	97.79	3.85	97.79
5	5.19	131.83	5.19	131.63	5.05	128.27	5.05	128.27	5.05	128.27	4.90	124.46	4.90	124.46
6	6.19	157.23	6.19	157.23	6.10	154.64	6.10	154.94	6.10	154.95	5.80	147.32	5.80	147.32
8	8.50	215.90	8.50	215.90	8.10	205.74	8.10	205.74	7.75	196.85	7.75	196.85	7.75	196.85
10	10.56	288.22	10.56	268.22	10.05	255.27	10.05	255.27	9.69	246.13	9.69	246.13	9.69	246.13
12	12.50	317.50	12.50	317.50	12.10	307.34	12.10	307.34	11.50	292.10	11.50	292.10	11.50	292.10
14	13.75	349.28	13.75	349.25	13.50	342.80	13.50	342.90	12.63	320.80	12.63	320.80	-	-
16	15.75	400.05	15.75	400.05	15.35	389.89	15.35	389.89	14.75	374.65	14.50	388.30	-	-
18	17.69	449.33	17.69	449.33	17.25	438.15	17.25	438.15	16.75	425.45	16.75	425.45	-	-
20	19.69	500.13	19.69	500.13	19.25	488.95	19.25	488.95	19.00	482.60	18.75	476.25	-	-
24	23.75	603.25	23.75	603.25	23.25	590.55	23.25	590.65	23.25	590.55	22.75	577.85	-	-

DIMENSIONS IN INCHES & MILLIMETERS.

In accordance with ASME B16.20, Inner Rings are mandatory for the following flange designations (see Table 3).

Class 900 - NPS 24 to 48

Class 1500 - NPS 12 to NPS 24

Class 2500 - NPS 4 to NPS 12

All PTFE filled gaskets

All flexible graphite gaskets unless otherwise requested by the customer

ASME B16.20 does not include dimensions for NPS 1/4, 3-1/2, or 4-1/2, or Class 400 Flanges up to NPS 3 and Class 900 Flanges up to NPS 2-1/2.

STYLE CG & CGI TO SUIT ASME B16.5 & BS 1560 SMALL DIAMETER SCREWED OR SLIP-ON FLANGES

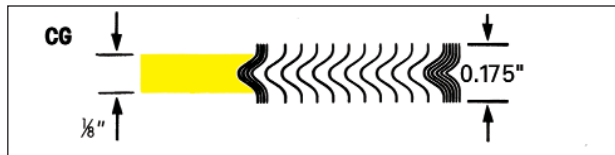

TABLE 4

Nom. Pipe Size	Inner Ring Inside Dia.		Sealing Element				Guide Ring Outside Diameter											
			Inside Dia.		Outside Dia.		Class 150		Class 300		Class 400		Class 600		Class 900		Class 1500	
1/4	-	-	9/16	14.3	7/8	22.2	1-3/4	44.5	1-3/4	44.5	1-3/4	44.5	1-3/4	44.5	-	-	-	-
1/2	9/16	14.3	15/16	23.8	1-1/4	31.8	1-7/8	47.6	2-1/8	54.0	2-1/8	54.0	2-1/8	54.0	2-1/2	63.5	2-1/2	63.5
3/4	13/16	20.6	1-3/16	30.2	1-9/16	39.7	2-1/4	57.2	2-5/8	66.7	2-5/8	66.7	2-5/8	66.7	2-3/4	69.9	2-3/4	69.9
1	1-1/16	27.0	1-7/16	36.5	1-7/8	47.6	2-5/8	66.7	2-7/8	73.0	2-7/8	73.0	2-7/8	73.0	3-1/8	79.4	3-1/8	79.4
1-1/4	1-3/8	34.9	1-7/8	47.6	2-3/8	60.3	3	76.2	3-1/4	82.6	3-1/4	82.6	3-1/4	82.6	3-1/2	88.9	3-1/2	88.9
1-1/2	1-5/8	41.3	2-1/8	54.0	2-3/4	69.9	3-3/8	85.7	3-3/4	95.3	3-3/4	95.3	3-3/4	95.3	3-7/8	98.4	3-7/8	98.4

DIMENSIONS IN INCHES & MILLIMETERS.

NOTE: The above style CG & CGI spiral wound gaskets are dimensioned to suit existing screwed or slip-on flanges for NPS 1/4 to 1-1/2 ASME B16.5 & BS 1560 flanges.



YOUR GLOBAL GASKET PROVIDER

资料整理：广州捷皓机械设备有限公司

www.gz-keephope.com

MAXIMUM BORE OF ASME B16.5 FLANGES FOR USE WITH STYLE CG & CGI SPIRAL WOUND GASKETS

This table shows the maximum bore of flanges for which the Spiral Wound gasket dimensions shown are recommended considering the tolerances involved, possible eccentric installation, and the possibility that the gasket may extend into the assembled flange bore.

**TABLE
5**

FLANGE SIZE (NPS)	PRESSURE CLASS													
	75	150	300	400	600	900	1500*	2500*						
1/2	No flanges	WN flange only ^b	No flanges Use Class 600	WN flange only ^b	No flanges Use Class 1500	WN flange only ^b								
3/4														
1														
1-1/4		SO flange ^c WN flange ^b		SO flange ^c WN flange ^b										
1-1/2														
2														
2-1/2		SO flange ^c WN flange, any bore ^b		SO flange ^c WN flange, any bore										
3														
4		No flanges		No flanges					No flanges	SO flange ^c WN flange, any bore	No flanges	WN flange with SW bore (includes nozzle ^d but excludes SO flange)		
6														
8	WN flange with Schedule 10S bore described in ASME B36.19M (includes nozzle ^d but excludes SO flange)		WN Flange with Schedule 80 bore (excludes nozzle and SO flange)											
10														
12	SO flange WN flange, any bore		WN flange with Schedule 10S bore described in ASME B36.19M (excludes nozzle ^d and SO flange) ^e		No flanges									
14														
16														
18														
20														
24														

Notes: SO = slip on and threaded; WN = welding neck; SW = standard wall.

^a Inner rings are required for Class 900 gaskets, NPS 24; Class 1500 gaskets, NPS 12 through NPS 24; and Class 2500 gaskets; NPS 4 through NPS 12. These inner rings may extend into the pipe bore a maximum of 0.06 inch (1.5 millimeters) under the worst combination of maximum bore, eccentric installation, and additive tolerances.

^b In these sizes the gasket is suitable for welding-neck flange with a standard-wall bore, if the gasket and the flanges are assembled concentrically. This also applies to nozzle. It is the user's responsibility to determine if the gasket is satisfactory for a flange of any larger bore.

^c Gaskets in these sizes are suitable for slip-on flanges only if the gaskets and flanges are assembled concentrically.

^d A nozzle is a long welding neck; the bore equals the flange NPS.

^e An NPS 24 gasket is suitable for nozzles.

* Spiral Wound gasket dimensions for use on screwed or slip-on flanges - see Table 4.

STYLE CG & CGI TO ASME B16.20
TO SUIT LARGE DIAMETER ASME B16.47 SERIES B FLANGES
CLASS 75-300

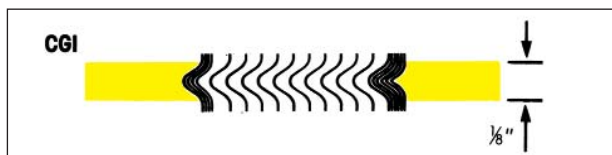
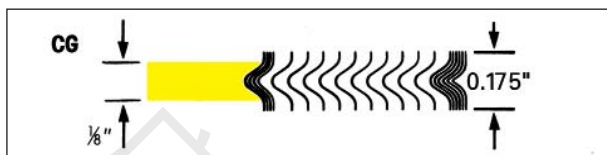

TABLE
6

NOM PIPE SIZE	CLASS 75			CLASS 150				CLASS 300			
	SEALING ELEMENT		CENTERING RING OUTSIDE DIA.	INNER RING INSIDE DIA.	SEALING ELEMENT		CENTERING RING OUTSIDE DIA.	INNER RING INSIDE DIA.	SEALING ELEMENT		CENTERING RING OUTSIDE DIA. ELEMENT
	INSIDE DIA.	OUTSIDE DIA.			INSIDE DIA.	OUTSIDE DIA.			INSIDE DIA.	OUTSIDE DIA.	
26	26-1/4	27	27-7/8	25-3/4	26-1/2	27-1/2	28-9/16	25-3/4	26-1/2	28	30-3/8
28	28-1/4	29-1/8	29-7/8	27-3/4	28-1/2	29-1/2	30-9/16	27-3/4	28-1/2	30	32-1/2
30	30-1/4	31-1/8	31-7/8	29-3/4	30-1/2	31-1/2	32-9/16	29-3/4	30-1/2	32	34-7/8
32	32-1/4	33-1/8	33-7/8	31-3/4	32-1/2	33-1/2	34-11/16	31-3/4	32-1/2	34	37
34	34-1/4	35-1/8	35-7/8	33-3/4	34-1/2	35-3/4	36-13/16	33-3/4	34-1/2	36	39-1/8
36	36 1/4	37-1/4	38-5/16	35-3/4	36-1/2	37-3/4	38-7/8	35-3/4	36-1/2	38	41-1/4
38	-	-	-	37-3/4	38-3/8	39-3/4	41-1/8	38-1/4	39-3/4	41-1/4	43-1/4
40	-	-	-	39-3/4	40-1/4	41-7/8	43-1/8	40-1/4	41-3/4	43-1/4	45-1/4
42	42-1/4	43-1/4	44-5/16	41-3/4	42-1/2	43-7/8	45-1/8	42-3/4	43-3/4	45-1/4	47-1/4
44	-	-	-	43-3/4	44-1/4	45-7/8	47-1/8	44-1/4	45-3/4	47-1/4	49-1/4
46	-	-	-	45-3/4	46-1/2	48-3/16	49-7/16	46-3/8	47-7/8	49-3/8	51-7/8
48	48-3/8	49-1/2	50-1/2	47-3/4	48-1/2	50	51-7/16	48-1/2	49-3/4	51-5/8	53-7/8
50	-	-	-	49-3/4	50-1/2	52-3/16	53-7/16	49-7/8	51-7/8	53-3/8	55-7/8
52	-	-	-	51-3/4	52-1/2	54-3/16	55-7/16	51-7/8	53-7/8	55-3/8	57-7/8
54	54 3/8	55-5/8	56-5/8	53-3/4	54-1/2	56	57-5/8	53-3/4	55-1/4	57-1/4	60-1/4
56	-	-	-	56	56-7/8	58-3/16	59-5/8	56-1/4	58-1/4	60	62-3/4
58	-	-	-	58-3/16	59-1/16	60-3/16	62-3/16	58-7/16	60-7/16	61-15/16	65-3/16
60	60 1/2	61-3/4	62-7/8	60-7/16	61-5/16	62-7/16	64-3/16	61-5/16	62-9/16	64-3/16	67-3/16

DIMENSIONS IN INCHES.

Note: Gasket dimensions to suit Class 75 flanges are not specified in ASME B16.20. These gaskets have been dimensioned to suit the flanges.

STYLE CG & CGI TO ASME B16.20
TO SUIT LARGE DIAMETER ASME B16.47 SERIES B FLANGES
CLASS 75-300

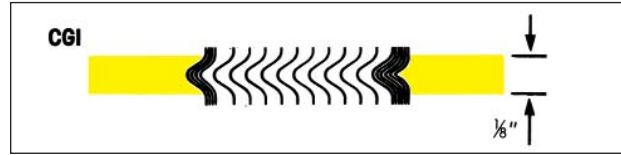
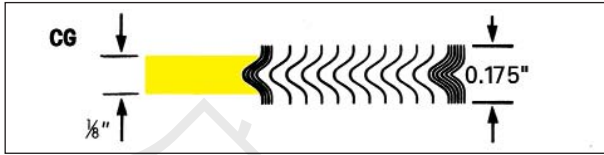

TABLE 6.1

NOM PIPE SIZE	CLASS 400				CLASS 600				CLASS 900*			
	INNER RING INSIDE DIA.	SEALING ELEMENT		CENTERING RING OUTSIDE DIA.	INNER RING INSIDE DIA.	SEALING ELEMENT		CENTERING RING OUTSIDE DIA.	INNER RING INSIDE DIA.	SEALING ELEMENT		CENTERING RING OUTSIDE DIA. ELEMENT
		INSIDE DIA.	OUTSIDE DIA.			INSIDE DIA.	OUTSIDE DIA.			INSIDE DIA.	OUTSIDE DIA.	
26	25-3/4	26-1/4	27-1/2	29-3/8	25-3/8	26-1/8	28-1/8	30-1/8	26-1/4	27-1/4	29-1/2	33
28	27-5/8	28-1/8	29-1/2	31-1/2	27	27-3/4	39-3/4	32-1/4	28-1/4	29-1/4	31-1/2	35-1/2
30	29-5/8	30-1/8	31-3/4	33-3/4	29-5/8	30-5/8	32-5/8	34-5/8	31-3/4	30-3/4	33-3/4	37-3/4
32	31-1/2	32	33-7/8	35-7/8	31-1/4	32-3/4	34-3/4	36-3/4	33	34	36	40
34	33-1/2	34-1/8	35-7/8	37-7/8	33-1/2	35	37	39-1/4	35-1/4	36-1/4	38-1/4	42-1/4
36	35-3/8	36-1/8	38	40-1/4	35-1/2	37	39	41-1/4	36-1/4	37-1/4	39-1/4	44-1/4
38	37-1/2	38-1/4	40-1/4	42-1/4	37-1/2	39	41	43-1/2	39-3/4	40-3/4	42-3/4	47-1/4
40	39-3/8	40-3/8	42-3/8	44-3/8	39-3/4	41-1/4	43-1/4	45-1/2	41-3/4	43-1/4	45-1/4	49-1/4
42	41-3/8	42-3/8	44-3/8	46-3/8	42	43-1/2	45-1/2	48	43-3/4	45-1/4	47-1/4	51-1/4
44	43-1/2	44-1/2	46-1/2	48-1/2	43-3/4	45-3/4	47-3/4	50	45-1/2	47-1/2	49-1/2	53-7/8
46	46	47	49	50-3/4	45-3/4	47-3/4	49-3/4	52-1/4	48	50	52	56-1/2
48	47-1/2	49	51	53	48	50	52	54-3/4	50	52	54	58-1/2
50	49-1/2	51	53	55-1/4	50	52	54	57	-	-	-	-
52	51-1/2	53	55	57-1/4	52	54	56	59	-	-	-	-
54	53-1/4	55-1/4	57-1/4	59-3/4	54-1/4	56-1/4	58-1/4	61-1/4	-	-	-	-
56	55-1/4	57-1/4	59-1/4	61-3/4	56-1/4	58-1/4	60-1/4	63-1/2	-	-	-	-
58	57-1/4	59-1/4	61-1/4	63-3/4	58	60-1/2	62-1/2	65-1/2	-	-	-	-
60	59-3/4	61-3/4	63-3/4	66-1/4	60-1/4	62-3/4	64-3/4	68-1/4	-	-	-	-

DIMENSIONS IN INCHES.

*Inner rings are mandatory for Class 900 flanges, NPS 26 to 48.

Note: Gasket dimensions to suit Class 75 flanges are not specified in ASME B16.20. These gaskets have been dimensioned to suit the flanges.

YOUR GLOBAL GASKET PROVIDER



STYLE CG & CGI TO ASME B16.20
TO SUIT LARGE DIAMETER ASME B16.47 SERIES B FLANGES
CLASS 75-300

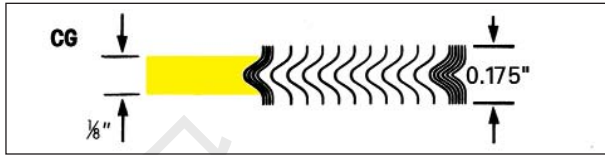

TABLE
7

NOM PIPE SIZE	CLASS 150				CLASS 300			
	INNER RING INSIDE DIA.	SEALING ELEMENT		CENTERING RING OUTSIDE DIA.	INNER RING INSIDE DIA.	SEALING ELEMENT		CENTERING RING OUTSIDE DIA. ELEMENT
		INSIDE DIA.	OUTSIDE DIA.			INSIDE DIA.	OUTSIDE DIA.	
26	654.1	673.1	698.5	725.4	654.1	673.1	711.2	771.7
28	704.9	723.9	749.3	776.2	704.9	723.9	762.0	825.5
30	755.7	774.7	800.1	827.0	755.7	774.7	812.8	886.0
32	806.5	825.5	850.9	881.1	806.5	825.5	863.6	939.8
34	857.3	876.3	908.1	935.0	857.3	876.3	914.4	993.9
36	908.1	927.1	958.9	987.6	908.1	927.1	965.2	1047.8
38	958.9	974.9	1009.7	1044.7	971.6	1009.7	1047.8	1098.6
40	1009.7	1022.4	1063.8	1095.5	1022.4	1060.5	1098.6	1149.4
42	1060.5	1079.5	1114.6	1146.3	1085.9	1111.3	1149.4	1200.2
44	1111.3	1124.0	1165.4	1197.1	1124.0	1162.1	1200.2	1251.0
46	1162.1	1181.1	1224.0	1255.8	1178.1	1216.2	1254.3	1317.8
48	1212.9	1231.9	1270.0	1306.6	1231.9	1263.7	1311.4	1368.6
50	1263.7	1282.7	1325.6	1357.4	1267.0	1317.8	1355.9	1419.4
52	1314.5	1333.5	1376.4	1408.2	1317.8	1368.6	1406.7	1470.2
54	1365.3	1384.3	1422.4	1463.8	1365.3	1403.4	1454.2	1530.4
56	1422.4	1444.8	1478.0	1514.6	1428.8	1479.6	1524.0	1593.9
58	1478.0	1500.0	1528.8	1579.6	1484.4	1535.2	1573.3	1655.8
60	1535.2	1557.3	1586.0	1630.4	1557.3	1589.0	1630.4	1706.6

DIMENSIONS IN MILLIMETERS.

Note: Gasket dimensions to suit Class 75 flanges are not specified in ASME B16.20. These gaskets have been dimensioned to suit the flanges.

STYLE CG & CGI TO ASME B16.20
TO SUIT LARGE DIAMETER ASME B16.47 SERIES B FLANGES
CLASS 75-300

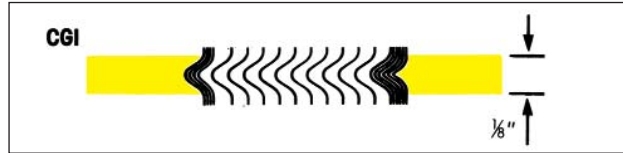
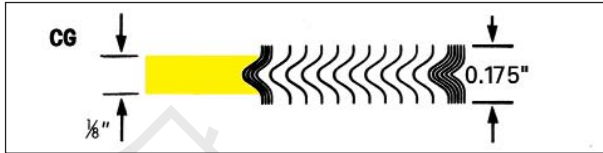

TABLE 7.1

NOM PIPE SIZE	CLASS 400				CLASS 600				CLASS 900*			
	INNER RING INSIDE DIA.	SEALING ELEMENT		CENTER-ING RING OUTSIDE DIA.	INNER RING INSIDE DIA.	SEALING ELEMENT		CENTER-ING RING OUTSIDE DIA.	INNER RING INSIDE DIA.	SEALING ELEMENT		CENTER-ING RING OUTSIDE DIA. ELEMENT
		INSIDE DIA.	OUTSIDE DIA.			INSIDE DIA.	OUTSIDE DIA.			INSIDE DIA.	OUTSIDE DIA.	
26	654.1	666.8	698.5	746.3	644.7	663.7	714.5	765.3	666.8	692.2	749.3	838.2
28	701.8	714.5	749.3	800.1	685.8	704.9	755.7	819.2	717.6	743.0	800.1	901.7
30	752.6	765.3	806.5	857.3	752.6	778.0	828.8	879.6	781.1	806.5	857.3	958.9
32	800.1	812.8	860.6	911.4	793.8	831.9	882.7	933.5	838.2	863.6	914.4	1016.0
34	850.9	866.9	911.4	962.2	850.9	889.0	939.8	997.0	895.4	920.8	971.6	1073.2
36	898.7	917.7	965.2	1022.4	901.7	939.8	990.6	1047.8	920.8	946.2	997.0	1124.0
38	952.5	971.6	1022.4	1073.2	952.5	990.6	1041.4	1104.9	1009.7	1035.1	1085.9	1200.2
40	1000.3	1025.7	1076.5	1127.3	1009.7	1047.8	1098.6	1155.7	1060.5	1098.6	1149.4	1251.0
42	1051.1	1076.5	1127.3	1178.1	1066.8	1104.9	1155.7	1219.2	1111.3	1149.4	1200.2	1301.8
44	1104.9	1130.3	1181.1	1231.9	1111.3	1162.1	1212.9	1270.0	1155.7	1206.5	1257.3	1368.6
46	1168.4	1193.8	1244.6	1289.1	1162.1	1212.9	1263.7	1327.2	1219.2	1270.0	1320.8	1435.1
48	1206.5	1244.6	1295.4	1346.2	1219.2	1270.0	1320.8	1390.7	1270.0	1320.8	1371.6	1485.9
50	1257.3	1295.4	1346.2	1403.4	1270.0	1320.8	1371.6	1447.8	-	-	-	-
52	1308.1	1346.2	1397.0	1454.2	1320.8	1371.6	1422.4	1498.6	-	-	-	-
54	1352.6	1403.4	1454.2	1517.7	1378.0	1428.8	1479.6	1555.8	-	-	-	-
56	1403.4	1454.2	1505.0	1568.5	1428.8	1479.6	1530.4	1612.9	-	-	-	-
58	1454.2	1505.0	1555.8	1619.3	1473.2	1536.7	1587.5	1663.7	-	-	-	-
60	1517.7	1568.5	1619.3	1682.8	1530.4	1593.9	1644.7	1733.6	-	-	-	-

DIMENSIONS IN MILLIMETERS.

*Inner rings are mandatory for Class 900 flanges, NPS 26 to 48.

Note: Gasket dimensions to suit Class 75 flanges are not specified in ASME B16.20. These gaskets have been dimensioned to suit the flanges.

STYLE CG & CGI TO ASME B16.20
TO SUIT LARGE DIAMETER ASME B16.47 SERIES A FLANGES
CLASS 150-300

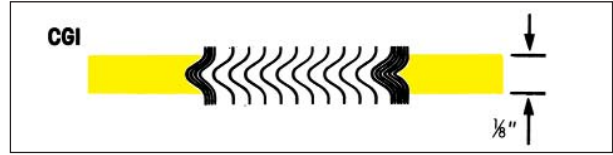
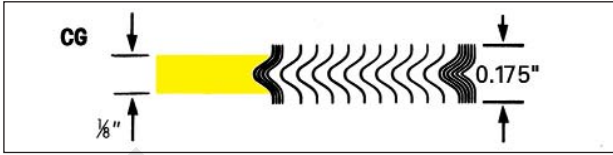

TABLE 8

NOM PIPE SIZE	CLASS 150				CLASS 300			
	INNER RING INSIDE DIA.	SEALING ELEMENT		CENTERING RING OUTSIDE DIA.	INNER RING INSIDE DIA.	SEALING ELEMENT		CENTERING RING OUTSIDE DIA. ELEMENT
		INSIDE DIA.	OUTSIDE DIA.			INSIDE DIA.	OUTSIDE DIA.	
22	-	22-3/4	24	26	-	22-3/4	24-3/4	27-3/4
26	25-3/4	26-1/2	27-3/4	30-1/2	25-3/4	27	29	32-7/8
28	27-3/4	28-1/2	29-3/4	32-3/4	27-3/4	29	31	35-3/8
30	29-3/4	30-1/2	31-3/4	34-3/4	29-3/4	31-1/4	33-1/4	37-1/2
32	31-3/4	32-1/2	33-7/8	37	31-3/4	33-1/2	35-1/2	39-5/8
34	33-3/4	34-1/2	35-7/8	39	33-3/4	35-1/2	37-1/2	41-5/8
36	35-3/4	36-1/2	38-1/8	41-1/4	35-3/4	37-5/8	39-5/8	44
38	37-3/4	38-1/2	40-1/8	43-3/4	37-1/2	38-1/2	40	41-1/2
40	39-3/4	40-1/2	42-1/8	45-3/4	39-1/2	40-1/4	42-1/8	43-7/8
42	41-3/4	42-1/2	44-1/4	48	41-1/2	42-1/4	44-1/8	45-7/8
44	43-3/4	44-1/2	46-3/8	50-1/4	43-1/2	44-1/2	46-1/2	48
46	45-3/4	46-1/2	48-3/8	52-1/4	45-5/8	46-3/8	48-3/8	50-1/8
48	47-3/4	48-1/2	50-3/8	54-1/2	47-5/8	48-5/8	50-5/8	52-1/8
50	49-3/4	50-1/2	52-1/2	56-1/2	49	51	53	54-1/4
52	51-3/4	52-1/2	54-1/2	58-3/4	52	53	55	56-1/4
54	53-1/2	54-1/2	56-1/2	61	53-1/4	55-1/4	57-1/4	58-3/4
56	55-1/2	56-1/2	58-1/2	63-1/4	55-1/4	57-1/4	59-1/4	60-3/4
58	57-1/2	58-1/2	60-1/2	65-1/2	57	59-1/2	61-1/2	62-3/4
60	59-1/2	60-1/2	62-1/2	67-1/2	60	61-1/2	63-1/2	64-3/4

DIMENSIONS IN INCHES

The above style CG gasket dimensions are also suitable for NPS 26 to 48 class 150 and NPS 26 to 36 class 300 BS 3293 flanges.



YOUR GLOBAL GASKET PROVIDER

**STYLE CG & CGI TO ASME B16.20
TO SUIT LARGE DIAMETER ASME B16.47 SERIES A FLANGES
CLASS 400-600-900**

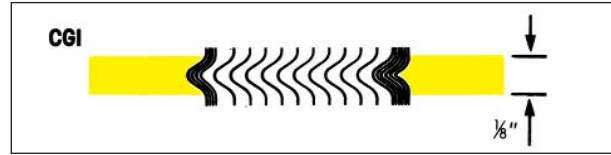
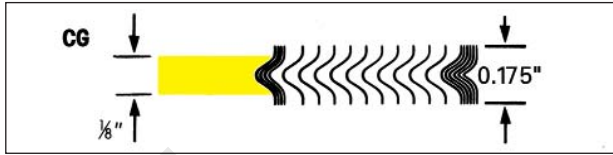

TABLE 8.1

NOM PIPE SIZE	CLASS 400				CLASS 600				CLASS 900*			
	INNER RING INSIDE DIA.	SEALING ELEMENT		CENTERING RING OUTSIDE DIA.	INNER RING INSIDE DIA.	SEALING ELEMENT		CENTERING RING OUTSIDE DIA.	INNER RING INSIDE DIA.	SEALING ELEMENT		CENTERING RING OUTSIDE DIA. ELEMENT
		INSIDE DIA.	OUTSIDE DIA.			INSIDE DIA.	OUTSIDE DIA.			INSIDE DIA.	OUTSIDE DIA.	
22	-	22-3/4	24-3/4	27-5/8	-	22-3/4	34-3/4	28-7/8	-	-	-	-
26	26	27	29	32-3/4	25-1/2	27	29	34-1/8	26	27	29	34-3/4
28	28	29	31	35-1/8	27-1/2	29	31	36	28	29	31	37-1/4
30	29-3/4	31-1/4	33-1/4	37-1/4	29-3/4	31-1/4	33-1/4	38-1/4	30-1/4	31-1/4	33-1/4	39-3/4
32	32	33-1/2	35-1/2	39-1/2	32	33-1/2	35-1/2	40-1/4	32	33-1/2	35-1/2	42-1/4
34	34	35-1/2	37-1/2	41-1/2	34	35-1/2	37-1/2	42-1/4	34	35-1/2	37-1/2	44-3/4
36	36-1/8	37-5/8	39-5/8	44	36-1/8	37-5/8	39-5/8	44-1/2	36-1/4	37-3/4	39-3/4	47-1/4
38	37-1/2	38-1/4	40-1/4	42-1/4	37-1/2	39	41	43-1/2	39-3/4	40-3/4	42-3/4	47-1/4
40	39-3/8	40-3/8	42-3/8	44-3/8	39-3/4	41-1/4	43-1/4	45-1/2	41-3/4	43-1/4	45-1/4	49-1/4
42	41-3/8	42-3/8	44-3/8	46-3/8	42	43-1/2	45-1/2	48	43-3/4	45-1/4	47-1/4	51-1/4
44	43-1/2	44-1/2	46-1/2	48-1/2	43-3/4	45-3/4	47-3/4	50	45-1/2	47-1/2	49-1/2	53-7/8
46	46	47	49	50-3/4	45-3/4	47-3/4	49-3/4	52-1/4	48	50	52	56-1/2
48	47-1/2	49	51	53	48	50	52	54-3/4	50	52	54	58-1/2
50	49-1/2	51	53	55-1/4	50	52	54	57	-	-	-	-
52	51-1/2	53	55	57-1/4	52	54	56	59	-	-	-	-
54	53-1/4	55-1/4	57-1/4	59-3/4	54-1/4	56-1/4	58-1/4	61-1/4	-	-	-	-
56	55-1/4	57-1/4	59-1/4	61-3/4	56-1/4	58-1/4	60-1/4	63-1/2	-	-	-	-
58	57-1/4	59-1/4	61-1/4	63-3/4	58	60-1/2	62-1/2	65-1/2	-	-	-	-
60	59-3/4	61-3/4	63-3/4	66-1/4	60-1/4	62-3/4	64-3/4	68-1/4	-	-	-	-

DIMENSIONS IN INCHES

NOTE: There are no class 900 flanges NPS 50 and larger.

*Inner rings are mandatory for class 900 flanges, NPS 26 to 48.

For ASME B16.47 Series A flanges NPS 12 to 24 use gasket dimensions listed on page 8, for ASME B 16.5 flanges.

The above style CG gasket dimensions are also suitable for NPS 26 to 36 class 400 and 600 BS 3293 flanges.

YOUR GLOBAL GASKET PROVIDER



STYLE CG & CGI TO ASME B16.20
TO SUIT LARGE DIAMETER ASME B16.47 SERIES A FLANGES
CLASS 150-300

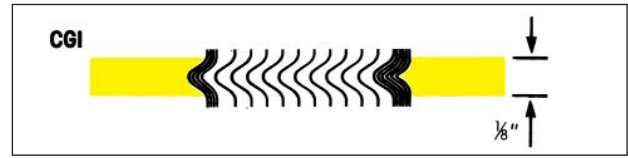
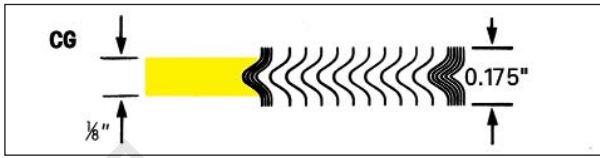

TABLE 9

NOM PIPE SIZE	CLASS 150				CLASS 300			
	INNER RING INSIDE DIA.	SEALING ELEMENT		CENTERING RING OUTSIDE DIA.	INNER RING INSIDE DIA.	SEALING ELEMENT		CENTERING RING OUTSIDE DIA. ELEMENT
		INSIDE DIA.	OUTSIDE DIA.			INSIDE DIA.	OUTSIDE DIA.	
26	654.1	673.1	704.9	774.7	654.1	685.8	736.6	835.2
28	704.9	723.9	755.7	831.9	704.9	736.6	787.4	898.7
30	755.7	774.7	806.5	882.7	755.7	793.8	844.6	952.5
32	806.5	825.5	860.6	939.8	806.5	850.9	901.7	1006.6
34	857.3	876.3	911.4	990.6	857.3	901.7	952.5	1057.4
36	908.1	927.1	968.5	1047.8	908.1	955.8	1006.6	1117.6
38	958.9	977.9	1019.3	1111.3	952.5	977.9	1016.0	1054.1
40	1009.7	1028.7	1070.1	1162.1	1003.3	1022.4	1070.1	1114.6
42	1060.5	1079.5	1124.0	1219.2	1054.1	1073.2	1120.9	1165.4
44	1111.3	1130.3	1178.1	1276.4	1104.9	1130.3	1181.1	1219.2
46	1162.1	1181.1	1228.9	1327.2	1152.7	1178.1	1228.9	1273.3
48	1212.9	1231.9	1279.7	1384.3	1209.8	1235.2	1286.0	1324.1
50	1263.7	1282.7	1333.5	1435.1	1244.6	1295.4	1346.2	1378.0
52	1314.5	1333.5	1384.3	1492.3	1320.8	1346.2	1397.0	1428.8
54	1358.9	1384.3	1435.1	1549.4	1352.6	1403.4	1454.2	1492.3
56	1409.7	1435.1	1485.9	1606.6	1403.4	1454.2	1505.0	1543.1
58	1460.5	1485.9	1536.7	1663.7	1447.8	1511.3	1562.1	1593.9
60	1511.3	1536.7	1587.5	1714.5	1524.0	1562.1	1612.9	1644.7

DIMENSIONS IN MILLIMETERS

The above style CG gasket dimensions are also suitable for NPS 26 to 48 class 150 and NPS 26 to 36 class 300 BS 3293 flanges.

STYLE CG & CGI TO ASME B16.20
TO SUIT LARGE DIAMETER ASME B16.47 SERIES A FLANGES
CLASS 400-600-900

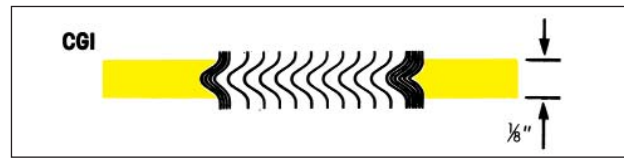
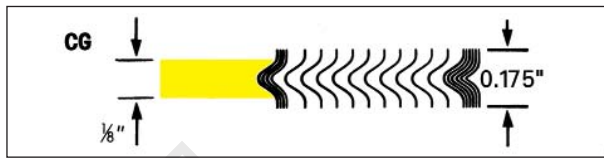

TABLE 9.1

NOM PIPE SIZE	CLASS 400				CLASS 600				CLASS 900*			
	INNER RING INSIDE DIA.	SEALING ELEMENT		CENTERING RING OUTSIDE DIA.	INNER RING INSIDE DIA.	SEALING ELEMENT		CENTERING RING OUTSIDE DIA.	INNER RING INSIDE DIA.	SEALING ELEMENT		CENTERING RING OUTSIDE DIA. ELEMENT
		INSIDE DIA.	OUTSIDE DIA.			INSIDE DIA.	OUTSIDE DIA.			INSIDE DIA.	OUTSIDE DIA.	
26	660.4	685.8	736.6	831.9	647.7	685.8	736.6	866.9	660.4	685.8	736.6	882.7
28	711.2	736.6	787.4	892.3	698.5	736.6	787.4	914.4	711.2	736.6	787.4	946.2
30	755.7	793.8	844.6	946.2	755.7	793.8	844.6	971.6	768.4	793.8	844.6	1009.7
32	812.8	850.9	901.7	1003.3	812.8	850.9	901.7	1022.4	812.8	850.9	901.7	1073.2
34	863.6	901.7	952.5	1054.1	863.6	901.7	952.5	1073.2	863.6	901.7	952.5	1136.7
36	917.7	955.8	1006.6	1117.6	917.7	955.8	1006.6	1130.3	920.8	958.9	1009.7	1200.2
38	952.5	971.6	1022.4	1073.2	952.5	990.6	1041.4	1104.9	1009.7	1035.1	1085.9	1200.2
40	1000.3	1025.7	1076.5	1127.3	1009.7	1047.8	1098.6	1155.7	1060.5	1098.6	1149.4	1251.0
42	1051.1	1076.5	1127.3	1178.1	1066.8	1104.9	1155.7	1219.2	1111.3	1149.4	1200.2	1301.8
44	1104.9	1130.3	1181.1	1231.9	1111.3	1162.1	1212.9	1270.0	1155.7	1206.5	1257.3	1368.6
46	1168.4	1193.8	1244.6	1289.1	1162.1	1212.9	1263.7	1327.2	1219.2	1270.0	1320.8	1435.1
48	1206.5	1244.6	1295.4	1346.2	1219.2	1270.0	1320.8	1390.7	1270.0	1320.8	1371.6	1485.9
50	1257.3	1295.4	1346.2	1403.4	1270.0	1320.8	1371.6	1447.8	-	-	-	-
52	1308.1	1346.2	1397.0	1454.2	1320.8	1371.6	1422.4	1498.6	-	-	-	-
54	1352.6	1403.4	1454.2	1517.7	1378.0	1428.8	1479.6	1555.8	-	-	-	-
56	1403.4	1454.2	1505.0	1568.5	1428.8	1479.6	1530.4	1612.9	-	-	-	-
58	1454.2	1505.0	1555.8	1619.3	1473.2	1536.7	1587.5	1663.7	-	-	-	-
60	1517.7	1568.5	1619.3	1682.8	1530.4	1593.9	1644.7	1733.6	-	-	-	-

DIMENSIONS IN MILLIMETERS

NOTE: There are no class 900 flanges NPS 50 and larger.

*Inner rings are mandatory for class 900 flanges, NPS 26 to 48.

For ASME B16.47 Series A flanges NPS 12 to 24 use gasket dimensions listed on page 8, for ASME B 16.5 flanges.

The above style CG gasket dimensions are also suitable for NPS 26 to 36 class 400 and 600 BS 3293 flanges.

STYLE CG & CGI
TO SUIT LARGE DIAMETER FLANGES
CLASS 75-125

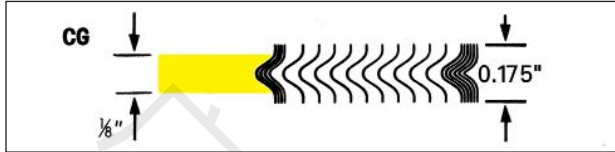

TABLE
10

CLASS 75 - SLIP-ON AND BLIND†				CLASS 75 - WELD-NECK AND BLIND†				CLASS 125			
Nom. Pipe Size	Sealing Element		Centering Ring Outside Dia.	Nom. Pipe Size	Sealing Element		Centering Ring Outside Dia.	Nom. Pipe Size	Sealing Element		Centering Ring Outside Dia.
	Inside Dia.	Outside Dia.			Inside Dia.	Outside Dia.			Inside Dia.	Outside Dia.	
26	27	28-1/4	30-1/8	26	26-1/2	27-3/4	28-3/4	26	26-1/2	27-3/4	30-1/2
28	29	30-1/4	32-1/8	28	28-1/2	29-3/4	30-3/4	28	28-1/2	29-3/4	32-3/4
30	31	32-1/4	34-1/8	30	30-1/2	31-3/4	32-3/4	30	30-1/2	31-3/4	34-3/4
32	33-1/8	34-3/8	36-3/8	32	32-1/2	33-3/4	35-1/8	32	32-1/2	33-7/8	37
34	35-1/8	36-1/2	38-3/8	34	34-1/2	35-7/8	37-1/8	34	34-1/2	35-7/8	39
36	37-1/8	38-1/2	40-3/8	36	36-1/2	37-7/8	39-1/8	36	36-1/2	38-1/8	41-1/4
38	-	-	-	38	-	-	-	38	38-1/2	40-1/8	43-3/4
40	-	-	-	40	-	-	-	40	40-1/2	42-1/8	45-3/4
42	43-1/4	44-3/4	46-5/8	42	42-1/2	44	45-5/8	42	42-1/2	44-1/4	48
44	-	-	-	44	-	-	-	44	44-1/2	46-3/8	50-1/4
46	-	-	-	46	-	-	-	46	46-1/2	48-3/8	52-1/4
48	49-1/4	50-7/8	52-5/8	48	48-1/2	50-1/8	51-5/8	48	48-1/2	50-3/8	54-1/2
50	-	-	-	50	-	-	-	50	50-1/2	52-1/2	56-1/2
52	-	-	-	52	-	-	-	52	52-1/2	54-1/2	58-3/4
54	55-3/8	57-3/4	59-1/8	54	54-1/2	56-3/8	57-7/8	54	54-1/4	56-1/2	61
60	61-3/8	63-3/8	65-1/8	60	60-1/2	62-1/2	63-7/8	60	60-1/2	62-1/2	67-1/2
66	67-1/2	69-1/2	71-3/4	66	66-1/2	68-1/2	70-1/4	66	71	72-3/4	74-1/4
72	73-1/2	75-1/2	77-3/4	72	72-1/2	74-1/2	76-1/4	72	77-1/2	79-1/4	80-3/4
84	-	-	-	84	-	-	-	84	90-1/4	92	93-1/2
96	-	-	-	96	-	-	-	96	103	104-3/4	106-1/4

DIMENSIONS IN INCHES.

†Outside diameter, facing diameter and drilling of Class 75 Blind flanges depend on whether they are to be used against weld-neck or slip-on flanges.

*Where Style CGI gaskets are required, inner ring I.D. must be specified. Standard Practice is to use inner rings with an I.D. that is 0.125 in (3.2 mm) greater than the flange bore.

STYLE CG & CGI
TO SUIT LARGE DIAMETER FLANGES
CLASS 175-350

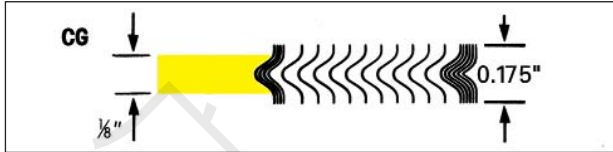

TABLE
10.1

Nom. Pipe Size	Sealing Element		Centering Ring Outside Dia.
	Inside Dia.	Outside Dia.	
26	26-1/2	27-3/4	29-1/8
28	28-1/2	29-3/4	31-1/8
30	30-1/2	31-3/4	33-3/8
32	32-1/2	33-3/4	35-3/8
34	34 -1/2	35-7/8	37-1/2
36	36-1/2	37-7/8	39-1/2
38	38-1/2	39-7/8	41-1/2
40	40-1/2	42	43-1/2
42	42-1/2	44	45-7/8
44	44-1/2	46	47-7/8
46	46-1/2	48	49-7/8
48	48-1/2	50-1/8	51-7/8
50	50-1/2	52-1/4	53-7/8
52	52-1/2	54-3/8	56-1/8
54	54-1/2	56-3/8	58-1/8
60	60-1/2	62-1/2	64-1/8
66	67-1/8	68-7/8	70-1/8
72	73-3/8	75-1/8	76-5/8
84	87	88-3/4	90-1/4
96	99	100-3/4	102-1/4

Nom. Pipe Size	Sealing Element		Centering Ring Outside Dia.
	Inside Dia.	Outside Dia.	
26	26-1/2	27-3/4	32-3/4
28	28-1/2	29-3/4	35-1/4
30	30-1/2	31-3/4	37-1/2
32	32-1/2	33-7/8	39-3/4
34	34-1/2	35-7/8	41-3/4
36	36-1/2	38-1/8	44
38	38-1/2	40-1/8	46
40	40-1/2	42-1/8	48-1/4
42	42-1/2	44-1/4	50-3/4
44	44-1/2	46-3/8	53
46	46-1/2	48-3/8	55-1/4
48	48-1/2	50-3/8	58-3/4
50	-	-	-
52	-	-	-
54	-	-	-
60	-	-	-
66	-	-	-
72	-	-	-
84	-	-	-
96	-	-	-

Nom. Pipe Size	Sealing Element		Centering Ring Outside Dia.
	Inside Dia.	Outside Dia.	
26	26-1/2	27-3/4	29-5/8
28	28-1/2	29-3/4	31-5/8
30	30-1/2	31-3/4	33-7/8
32	32-1/2	33-7/8	35-7/8
34	34-1/2	35-7/8	37-7/8
36	36-1/2	38-1/8	40-3/8
38	38-1/2	40-1/8	42-3/8
40	40-1/2	42-1/8	44-3/8
42	42-1/2	44-1/4	46-5/8
44	44-1/2	46-3/8	49
46	46-1/2	48-3/8	51
48	48-1/2	50-3/8	53
50	-	-	-
52	52-1/2	54-1/4	57-3/8
54	54-1/2	56-1/2	59-3/8
60	60-1/2	62-1/2	65-3/8
66	66-1/2	68-1/2	72-1/2
72	75-1/4	77	78-1/2
84	88-3/8	90-1/8	91-5/8
96	100-3/4	102-1/2	104

DIMENSIONS IN INCHES.

**STYLE CG & CGI TO BS3381
TO SUIT BS1560 & ASME B16.5 FLANGES**

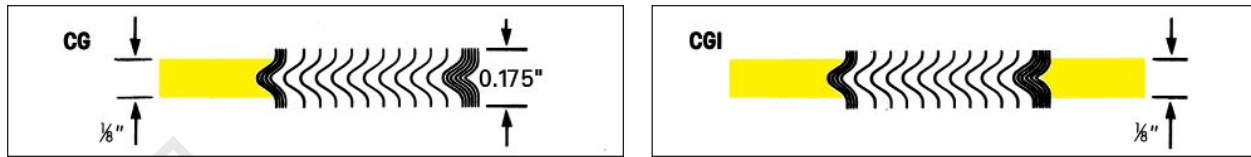

TABLE 11

NOM PIPE SIZE	INNER RING	CLASS 150			CLASS 300 to 1500		CLASS 300	CLASS 400	CLASS 600	CLASS 900	CLASS 1500	CLASS 2500		
		SEALING ELEMENT		CENTERING RING	SEALING ELEMENT		CENTERING RING					SEALING ELEMENT		CENTERING RING
		INSIDE DIA.	INSIDE DIA.	OUTSIDE DIA.	OUTSIDE DIA.	INSIDE DIA.	OUTSIDE DIA.	OUTSIDE DIAMETER					INSIDE DIA.	OUTSIDE DIA.
1/4	-	1/2*	7/8	1-3/4	1/2*	7/8	1-3/4	1-3/4	1-3/4	-	-	-	-	-
1/2	9/16	3/4*	1-1/4	1-7/8	3/4*	1-1/4	2-1/8	2-1/8	2-1/8	2-1/2	2-1/2	3/4	1-1/4	2-3/4
3/4	13/16	1-1/16*	1-9/16	2-1/4	1*	1-9/16	2-5/8	2-5/8	2-5/8	2-3/4	2-3/4	1	1-9/16	3
1	1-1/16	1-5/16*	1-7/8	2-5/8	1-1/4	1-7/8	2-7/8	2-7/8	2-7/8	3-1/8	3-1/8	1-1/4	1-7/8	3-3/8
1-1/4	1-3/8	1-13/16*	2-3/8	3	1-3/4	2-3/8	3-1/4	3-1/4	3-1/4	3-1/2	3-1/2	1-9/16	2-3/8	4-1/8
1-1/2	1-5/8	2-1/8	2-3/4	3-3/8	2*	2-3/4	3-3/4	3-3/4	3-3/4	3-7/8	3-7/8	1-7/8	2-3/4	4-5/8
2	2-1/16	2-3/4	3-3/8	4-1/8	2-5/8	3-3/8	4-3/8	4-3/8	4-3/8	5-5/8	5-5/8	2-5/16	3-3/8	5-3/4
2-1/2	2-1/2	3-1/4	3-7/8	4-7/8	3-1/8	3-7/8	5-1/8	5-1/8	5-1/8	6-1/2	6-1/2	2-3/4	3-7/8	6-5/8
3	3-1/16	4	4-3/4	5-3/8	3-3/4	4-3/4	5-7/8	5-7/8	5-7/8	6-5/8	6-7/8	3-5/8	4-3/4	7-3/4
3-1/2	3-9/16	4-1/2	5-1/4	6-3/8	4-1/4	5-1/4	6-1/2	6-3/8	6-3/8	-	-	-	-	-
4	4-1/16	5	5-7/8	6-7/8	4-3/4	5-7/8	7-1/8	7	7-5/8	8-1/8	8-1/4	4-3/4	5-7/8	9-1/4
4-1/2	4-9/16	5-9/16	6-1/2	7	5-5/16	6-1/2	7-3/4	-	-	-	-	-	-	-
5	5-1/16	6-1/16	7	7-3/4	5-13/16	7	8-1/2	8-3/8	9-1/2	9-3/4	10	5-13/16	7	11
6	6-1/16	7-1/8	8-1/4	8-3/4	6-7/8	8-1/4	9-7/8	9-3/4	10-1/2	11-3/8	11-1/8	6-7/8	8-1/4	12-1/2
8	8	9-1/8	10-3/8	11	8-7/8	10-3/8	12-1/8	12	12-5/8	14-1/8	13-7/8	8-7/8	10-3/8	15-1/4
10	10	11-5/16	12-1/2	13-3/8	11-1/16	12-1/2	14-1/4	14-1/8	15-3/4	17-1/8	17-1/8	11-1/16	12-1/2	18-3/4
12	11-15/16	13-3/8	14-3/4	16-1/8	13-1/8	14-3/4	16-5/8	16-1/2	18	19-5/8	20-1/2	13-1/8	14-3/4	21-5/8
14	13-1/2	14-5/8	16	17-3/4	14-3/8	16	19-1/8	19	19-3/8	20-1/2	22-3/4	-	-	-
16	15-1/2	16-5/8	18-1/4	20-1/4	16-3/8	18-1/4	21-1/4	21-1/8	22-1/4	22-5/8	25-1/4	-	-	-
18	17-1/2	18-3/4	20-3/4	21-5/8	18-1/2	20-3/4	23-1/2	23-3/8	24-1/8	25-1/8	27-3/4	-	-	-
20	19-1/2	20-3/4	22-3/4	23-7/8	20-1/2	22-3/4	25-3/4	25-1/2	26-7/8	27-1/2	29-3/4	-	-	-
24	23-1/2	24-7/8	27	28-1/4	24-5/8	27	30-1/2	30-1/4	31-1/8	33	35-1/2	-	-	-

DIMENSIONS IN INCHES.

*These gasket dimensions are not suitable for use with threaded or slip on flanges.
See Table 4 for special sizes.

In accordance with BS 3381 all class 900, 1500 and 2500 gaskets and all gaskets containing PTFE filler material shall have an inner ring.

**STYLE CG & CGI TO BS3381
TO SUIT BS1560 & ASME B16.5 FLANGES**

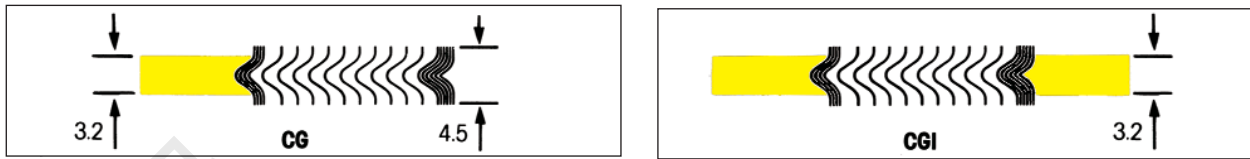

TABLE
12

NOM PIPE SIZE	INNER RING	CLASS 150				CLASS 300 to 1500		CLASS 300	CLASS 400	CLASS 600	CLASS 900	CLASS 1500	CLASS 2500		
		SEALING ELEMENT		CENTER- ING RING	SEALING ELEMENT	CENTERING RING							SEALING ELEMENT		CENTER- ING RING
		INSIDE DIA.	INSIDE DIA.			OUTSIDE DIA.	OUTSIDE DIA.	INSIDE DIA.	OUTSIDE DIA.	OUTSIDE DIAMETER					
1/4	-	12.7*	22.2	44.5	12.7*	22.2	44.5	44.5	44.5	-	-	-	-	-	
1/2	14.3	19.1*	31.8	47.6	19.1*	31.8	54.0	54.0	54.0	63.5	63.5	19.1	31.8	69.9	
3/4	20.6	27.0*	39.7	57.2	25.4*	39.7	66.7	66.7	66.7	69.9	69.9	25.4	39.7	76.2	
1	27.0	33.3*	47.6	66.7	31.8*	47.6	73.0	73.0	73.0	79.4	79.4	31.8	47.6	85.7	
1 1/4	34.9	46.0*	60.3	76.2	44.5*	60.3	82.6	82.6	82.6	88.9	88.9	39.7	60.3	104.8	
1 1/2	41.3	54.0	69.9	85.7	50.8*	69.9	95.3	95.3	95.3	98.4	98.4	47.6	69.9	117.5	
2	52.4	69.9	85.7	104.8	66.7	85.7	111.1	111.1	111.1	142.9	142.9	58.7	85.7	146.1	
2 1/2	63.5	82.6	98.4	123.8	79.4	98.4	130.2	130.2	130.2	165.1	165.1	69.9	98.4	168.3	
3	77.8	101.6	120.7	136.5	95.3	120.7	149.2	149.2	149.2	168.3	174.6	92.1	120.7	196.9	
3 1/2	90.5	114.3	133.4	161.9	108.0	133.4	165.1	161.9	161.9	-	-	-	-	-	
4	103.2	127.0	149.2	174.6	120.7	149.2	181.0	177.8	193.7	206.4	209.6	120.7	149.2	235.0	
4	115.9	141.3	165.1	177.8	134.9	165.1	196.9	-	-	-	-	-	-	-	
5	128.6	154.0	177.8	196.9	147.6	177.8	215.9	212.7	241.3	247.7	254.0	147.6	177.8	279.4	
6	154.0	181.0	209.6	222.3	174.6	209.6	250.8	247.7	266.7	288.9	282.6	174.6	209.6	317.5	
8	203.2	231.8	263.5	279.4	225.4	263.5	308.0	304.8	320.7	358.8	352.4	225.4	263.5	387.4	
10	254.0	287.3	317.5	339.7	281.0	317.5	362.0	358.8	400.1	435.0	435.0	281.0	317.5	476.3	
12	303.2	339.7	374.7	409.6	333.4	374.7	422.3	419.1	457.2	498.5	520.7	333.4	374.7	549.3	
14	342.9	371.5	406.4	450.9	365.1	406.4	485.8	482.6	492.1	520.7	577.9	-	-	-	
16	393.7	422.3	463.6	514.4	415.9	463.6	539.8	536.6	565.2	574.7	641.4	-	-	-	
18	444.5	476.3	527.1	549.3	469.9	527.1	596.9	593.7	612.8	638.2	704.9	-	-	-	
20	495.3	527.1	577.9	606.4	520.7	577.9	654.1	647.7	682.6	698.5	755.7	-	-	-	
24	596.9	631.8	685.8	717.6	625.5	685.8	774.7	768.4	790.6	838.2	901.7	-	-	-	

DIMENSIONS IN MILLIMETERS.

*These gasket dimensions are not suitable for use with threaded or slip on flanges.

See Table 4 for special sizes.

In accordance with BS 3381 all class 900, 1500 and 2500 gaskets and all gaskets containing PTFE filler material shall have an inner ring.

STYLE CG & CGI TO SUIT BS10 FLANGES

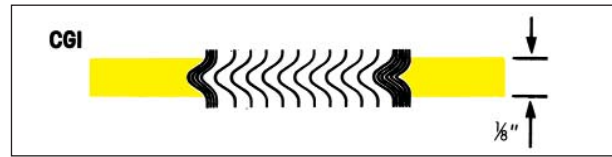
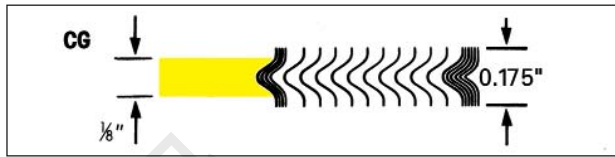

TABLE
13

NOM PIPE SIZE	TABLE D-R	TABLE D & E		TABLE D	TABLE E	TABLE F to R		TABLE F	TABLE H	TABLE J	TABLE K	TABLE R	TABLE S			TABLE T		
	INNER RING	SEALING ELEMENT		CENTERING RING		SEALING ELEMENT		CENTERING RING					SEALING ELEMENT		CENTERING RING	SEALING ELEMENT		CENTERING RING
	ID	ID	OD	OD	OD	ID	OD	OUTSIDE DIAMETER					ID	OD	OD	ID	OD	OD
1/2	9/16	1-1/32	1-5/32	2-1/8	2-1/8	1-1/32	1-17/32	2-1/8	2-5/8	2-5/8	2-5/8	2-5/8	3/4	1-1/4	2-3/4	3/4	1-1/4	3-1/4
3/4	1-3/16	1-1/4	1-11/16	2-3/8	2-3/8	1-1/4	1-3/4	2-3/8	2-5/8	2-5/8	2-5/8	2-5/8	1	1-9/16	2-3/4	1	1-9/16	3-1/4
1	1-1/16	1-9/16	2-1/16	2-3/4	2-3/4	1-9/16	2-3/16	2-13/16	2-13/16	2-13/16	3-1/8	3-1/8	1-1/4	1-7/8	3-1/4	1-1/4	1-7/8	3-1/2
1-1/4	1-5/16	1-7/8	2-3/8	2-15/16	2-15/16	1-7/8	2-1/2	3-1/4	3-1/4	3-1/4	3-1/4	3-1/4	1-1/2	2-3/16	3-1/2	1-5/8	2-5/16	3-7/8
1-1/2	1-9/16	2-1/8	2-5/8	3-3/8	3-3/8	2-1/8	2-3/4	3-1/2	3-1/2	3-1/2	3-3/4	3-3/4	1-3/4	2-1/2	4	1-7/8	2-5/8	4-1/2
2	2-1/16	2-5/8	3-1/8	3-7/8	3-7/8	2-5/8	3-1/4	4-3/8	4-3/8	4-1/4	4-3/8	4-3/8	2-1/4	3-1/8	4-1/2	2-3/8	3-1/4	5
2-1/2	2-9/16	3-1/4	3-7/8	4-3/8	4-3/8	3-1/4	4	5-1/8	5-1/8	5	5	5	2-7/8	3-3/4	5	3	3-7/8	5-5/8
3	3-1/16	3-13/16	4-7/16	5-1/8	5-1/8	3-13/16	4-9/16	5-7/8	5-7/8	5-3/4	5-3/4	5-3/4	3-3/8	4-1/4	5-5/8	3-1/2	4-1/2	6-1/2
3-1/2	3-9/16	4-5/16	4-15/16	5-7/8	5-7/8	4-5/16	5-1/16	6-3/8	6-3/8	6-1/4	6-3/8	6-3/8	3-7/8	4-3/4	6-5/8	4	5-1/8	7-3/8
4	4-1/16	4-7/8	5-1/2	6-3/8	6-3/8	4-7/8	5-5/8	6-7/8	6-7/8	6-3/4	6-7/8	6-7/8	4-3/8	5-3/8	7	4-1/2	5-5/8	8-1/8
4-1/2	4-9/16	5-3/8	6	6-7/8	6-7/8	5-3/8	6-1/4	7-1/2	7-1/2	7-3/8	7-3/8	7-3/8	4-7/8	5-7/8	7-1/2	5	6-1/4	9
5	5-1/16	5-7/8	6-1/2	7-5/8	7-5/8	5-7/8	6-3/4	8-1/2	8-1/2	8-3/8	8-3/8	8-3/8	5-3/8	6-3/8	8-3/8	5-1/2	6-3/4	9-5/8
6	6-1/16	6-7/8	7-1/2	8-5/8	8-1/2	6-7/8	7-3/4	9-1/2	9-1/2	9-3/8	9-3/8	9-3/8	6-3/8	7-3/8	9-3/4	6-1/2	7-3/4	11-1/4
7	7-1/16	7-7/8	8-5/8	9-5/8	9-1/2	7-7/8	8-7/8	10-3/4	10-3/4	10-5/8	10-1/2	10-1/2	7-3/8	8-5/8	11-3/8	7-1/2	9	13-1/8
8	8-1/16	8-7/8	9-5/8	10-7/8	10-3/4	8-7/8	9-7/8	12	12	11-7/8	11-1/2	11-3/4	8-3/8	9-5/8	12-3/4	8-1/2	10	14-1/2
9	9-1/16	9-7/8	10-5/8	12-1/8	12	9-7/8	10-7/8	13-1/8	13-1/8	13	13	13	9-1/2	10-3/4	14-1/8	9-5/8	11-1/4	16-1/8
10	10-1/16	10-7/8	11-5/8	13-1/4	13-1/4	11	12	14-1/8	14-1/8	14	14	14-1/4	10-1/2	11-7/8	15-1/2	10-5/8	12-1/4	17-3/4
11	11-1/16	11-7/8	12-5/8	14-1/4	14-1/4	12	13	15-1/8	15-1/8	15	15-1/8	15-7/8	11-1/2	12-7/8	17-1/8	11-5/8	13-1/4	19-1/4
12	12-1/16	12-7/8	13-3/4	15-1/4	15-1/8	13	14-1/8	16-3/8	16-3/8	16-1/4	15 7/8	16-7/8	12-5/8	14	18-1/2	12-3/4	14-1/2	20-3/4
13	13-1/16	14-1/2	15-3/8	16-1/2	16-3/8	14-1/4	15-3/8	17-1/2	17-1/2	17-3/8	17 3/4	18-1/4	13-5/8	15-1/8	19 3/4	13 3/4	15 1/2	22
14	14-1/16	15-1/2	16-3/8	17-5/8	17-5/8	15-1/4	16-3/8	18-1/2	18-1/2	18-3/8	18-3/4	19-1/2	14-5/8	16-1/8	21-1/4	-	-	-
15	15-1/16	16-1/2	17-3/8	18-5/8	18-5/8	16-1/4	17-3/8	19-1/2	19-1/2	19-3/8	20	20-1/2	15-3/4	17-1/4	22-7/8	-	-	-
16	16-1/16	17-1/2	18-3/8	19-5/8	19-5/8	17-1/2	18-3/4	20-3/4	20-3/4	20-5/8	21	21-3/4	16-3/4	18-3/8	24-1/4	-	-	-
17	17-1/16	18-5/8	19-5/8	20-7/8	20-3/4	18-1/2	19-7/8	22	22	21-7/8	22-1/4	22-3/4	-	-	-	-	-	-
18	18-1/16	19-5/8	20-5/8	22-1/8	22-1/8	19-1/2	20-7/8	22-7/8	22-7/8	22-3/4	24-3/8	25-1/8	-	-	-	-	-	-
19	19-1/16	20-5/8	21-5/8	23-1/8	23-1/8	20-5/8	22-1/8	24-1/8	24-1/8	24	-	-	-	-	-	-	-	-
20	20-1/16	21-5/8	22-5/8	24-3/8	24-3/8	21-5/8	23-1/8	25-3/8	25-3/8	25-1/4	26-1/2	27-1/4	-	-	-	-	-	-
21	21-1/16	22-5/8	23-3/4	25-5/8	25-1/2	22-5/8	24-3/8	26-3/8	26-3/8	26-1/4	-	-	-	-	-	-	-	-
22	22-1/16	23-5/8	24-3/4	26-1/2	26-1/2	23-5/8	25-3/8	27-3/8	27-3/8	27-1/4	28-3/4	29-3/4	-	-	-	-	-	-
23	23-1/16	24-5/8	25-3/4	27-1/2	27-1/2	24-5/8	26-3/8	28-1/2	28-1/2	28-3/8	-	-	-	-	-	-	-	-
24	24-1/16	25-5/8	26-3/4	28-3/4	28-5/8	25-5/8	27-3/8	29-1/2	29-1/2	29-3/8	-	-	-	-	-	-	-	-

DIMENSIONS IN INCHES.

NOTE: Special gasket dimensions are required when an inner ring is fitted to gaskets for Tables S and T.
Please request details.

**STYLE CG & CGI TO BS 4865 PART 2
TO SUIT BS 4504 FLANGES**

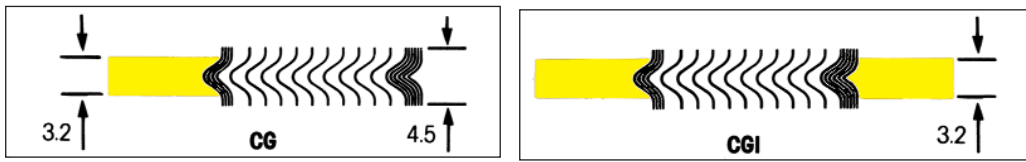

TABLE
14

NOM PIPE SIZE	Inner Ring Inside Diameter	Sealing Element PN10-PN40		Centering Ring Outside Diameter			
		Inside Dia.	Outside Dia.	PN10	PN16	PN25	PN40
10	15	23.6	36.4	48	48	48	48
15	19	27.6	40.4	53	53	53	53
20	24	33.6	47.4	63	63	63	63
25	30	40.6	55.4	73	73	73	73
32	39	49.6	66.4	84	84	84	84
40	45	55.6	72.4	94	94	94	94
50	56	67.6	86.4	109	109	109	109
65	72	83.6	103.4	129	129	129	129
80	84	96.6	117.4	144	144	144	144
100	108	122.6	144.4	164	164	170	170
125	133	147.6	170.4	194	194	196	196
150	160	176.6	200.4	220	220	226	226
200	209	228.6	255.4	275	275	286	293
250	262	282.4	310.4	330	331	343	355
300	311	331.6	360.4	380	386	403	420
350	355	374.6	405.4	440	446	460	477
400	406	425.6	458.4	491	498	517	549
450	452	476.6	512.4	541	558	567	574
500	508	527.6	566.4	596	620	627	631
600	610	634.6	675.4	698	737	734	750
700	710	734.0	778.5	813	807	836	-
800	811	835.0	879.5	920	914	945	-
900	909	933.0	980.5	1020	1014	1045	-

DIMENSIONS IN MILLIMETERS.

The use of an inner ring is recommended for gaskets for use with PN25 and PN40 flanges. Inner rings may be fitted also to gaskets for use with PN10 and PN16 flanges.

Ring thickness 2.97 mm to 3.33 mm.

STYLE CG & CGI TO SUIT DIN FLANGES PN 10-PN 160

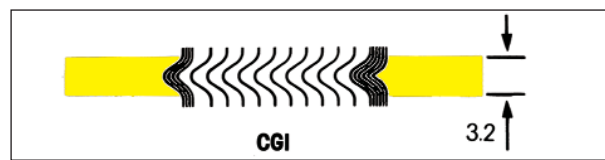
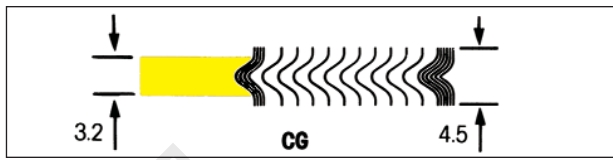

TABLE
15

NOM PIPE SIZE (DN)	INNER RING INSIDE DIAMETER	SEALING ELEMENT INSIDE DIAMETER	SEALING ELEMENT OUTSIDE DIAMETER		(DN)							
			PN10-PN40	PN64-PN250	PN10	PN16	PN25	PN40	PN64	PN100	PN160	PN250
10	18	24	34	34	46	46	46	46	56	56	56	67
15	23	29	39	39	51	51	51	51	61	61	61	72
20	28	34	46	-	61	61	61	61	72	72	-	-
25	35	41	53	53	71	71	71	71	82	82	82	83
32	43	49	61	-	82	82	82	82	87	87	-	-
40	50	56	68	68	92	92	92	92	103	103	103	109
50	61	70	86	86	107	107	107	107	113	119	119	124
65	77	86	102	106	127	127	127	127	138	144	144	154
80	90	99	115	119	142	142	142	142	148	154	154	170
100	115	127	143	147	162	162	168	168	174	180	180	202
125	140	152	172	176	192	192	194	194	210	217	217	242
150	167	179	199	203	217	217	224	224	247	257	257	284
175	189	199	225	231	247	247	254	265	277	287	284	316
200	216	228	248	252	272	272	284	290	309	324	324	358
250	267	279	303	307	327	328	340	352	364	391	388	442
300	318	330	354	358	377	383	400	417	424	458	458	538
350	360	376	400	404	437	443	457	474	486	512	-	-
400	410	422	450	456	488	495	514	546	543	572	-	-
500	510	522	550	556	593	617	624	628	657	704	-	-
600	610	622	650	656	695	734	731	747	764	813	-	-
700	710	722	756	762	810	804	833	852	879	-	-	-
800	810	830	864	870	917	911	942	974	988	-	-	-
900	910	930	964	970	1017	1011	1042	1084	1108	-	-	-
1000	1010	1030	1074	1080	1124	1128	1154	1194	1220	-	-	-

DIMENSIONS IN MILLIMETERS.

The use of an inner ring is recommended for gaskets for use with PN100 Flanges and above.
Gasket dimensions are available to suit PN250 and above, consult the technical department.

Ref: EN 1514-2:2005

STYLE R

FOR USE WITH MALE & FEMALE AND TONGUE & GROOVE ASME B16.5 & BS 1560 FLANGES

Standard Style R gaskets embody all the exclusive features of Flexitallic design for keeping compression values in balance with bolting and providing adequate resilience to compensate for variable stresses encountered in service. Standard Style R gaskets are manufactured to a nominal thickness of .125" (3.2mm). Optimum compression is in the range of .090" to .100" (2.3mm to 2.5mm) thick.

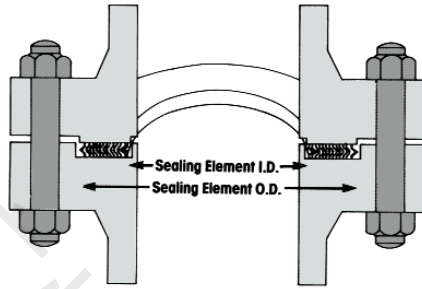

There are three types of Style R gaskets:

- (a) Style R-1 indicates gaskets for use with large male and female flanges.*
- (b) Style R-3 indicates gaskets for use with large tongue and groove flanges.
- (c) Style R-4 indicates gaskets for use with small tongue and groove flanges.

*As a general rule, the use of Flexitallic Spiral Wound gaskets with small male and female flange facings is not recommended.

Dimensional limitations established by the proportions of the small tongue and groove facings limit the possibility of increasing gasket dimensions to improve the load carrying capacity in the higher pressure series. For this reason, it is suggested that large tongue and groove facings be selected for new construction when class 900, 1500 and 2500 flanges are to be used. Style R-4 gaskets may be compressed an additional amount when exposed to the higher bolt loads, but not to the degree that the gasket will be crushed due to the radial support provided by the confining groove.

Special Style R gaskets are adaptable to non-standard flanges and can be designed and manufactured according to specifications for high and low pressure applications and for severe corrosive conditions.

When ordering special Style R gaskets for non-standard flanges and for special applications, furnish complete data on Flexitallic Gasket Engineering Data Form.

NOTE - The following Style R gaskets are interchangeable:

Style R-1 and R-3 gaskets

- 1/4" sizes - Classes 150, 300, 400 and 600 are interchangeable.
- 1/2" sizes - Classes 150, 300, 400, 600, 900, 1500 and 2500 (R-3 only) are interchangeable.
- All R-1 and R-3 gaskets in Classes 300, 400 and 600 are interchangeable within their size category.
- All R-1 and R-3 gaskets in Classes 900 and 1500 are interchangeable within their size category.

Style R-4 gaskets

- 1/2" sizes - interchangeable with all NPS 1/2" R-1 and R-3 gaskets within the same pressure rating.
- 3/4" interchangeable with all 3/4" R-1 and R-3 gaskets within the same pressure rating.
- All R-4 gaskets in Classes 300 through 2500 are interchangeable within their size category.

TABLE 16

NOM PIPE SIZE	Style R1 for Large Male and Female								Style R3 for Large Tongue and Groove				Style R4 for Small Tongue and Groove			
	Sealing Element Class 150-1500				Sealing Element Class 2500				Sealing Element Class 150 - 2500				Sealing Element Class 150 - 2500			
	ID	OD	ID	OD	ID	OD	ID	OD	ID	OD	ID	OD	ID	OD		
1/4	1/2	12.7	1	25.4	-	-	-	-	1/2	12.7	1	25.4	-	-	-	-
1/2	1	25.4	1-3/8	34.9	13/16	20.6	1-3/8	34.9	1	25.4	1-3/8	34.9	1	25.4	1-3/8	34.9
3/4	1-5/16	33.3	1-11/16	42.9	1-1/16	27.0	1-11/16	42.9	1-5/16	33.3	1-11/16	42.9	1-5/16	33.3	1-11/16	42.9
1	1-1/2	38.1	2	50.8	1-1/4	31.8	2	50.8	1-1/2	38.1	2	50.8	1-1/2	38.1	1-7/8	47.6
1 1/4	1-7/8	47.6	2-1/2	63.5	1-5/8	41.3	2-1/2	63.5	1-7/8	47.6	2-1/2	63.5	1-7/8	47.6	2-1/4	57.2
1 1/2	2-1/8	54.0	2-7/8	73.0	1-7/8	47.6	2-7/8	73.0	2-1/8	54.0	2-7/8	73.0	2-1/8	54.0	2-1/2	63.5
2	2-7/8	73.0	3-5/8	91.1	2-3/8	60.3	3-5/8	92.1	2-7/8	73.0	3-5/8	92.1	2-7/8	73.0	3-1/4	82.6
2 1/2	3-3/8	85.7	4-1/8	104.8	3	76.2	4-1/8	104.8	3-3/8	85.7	4-1/8	104.8	3-3/8	85.7	3-3/4	95.3
3	4-1/4	108.0	5	127.0	3-3/4	95.3	5	127.0	4-1/4	108.0	5	127.0	4-1/4	108.0	4-5/8	117.5
3 1/2	4-3/4	120.7	5-1/2	139.7	-	-	-	-	4-3/4	120.7	5-1/2	139.7	4-3/4	120.7	5-1/8	130.2
4	5-3/16	131.8	6-3/16	157.2	4-3/4	120.7	6-3/16	157.2	5-3/16	131.8	6-3/16	157.2	5-3/16	131.8	5-11/16	144.5
4 1/2	5-11/16	144.5	6-3/4	171.5	-	-	-	-	5-11/16	144.5	6-3/4	171.5	-	-	-	-
5	6-5/16	160.3	7-5/16	185.7	5-3/4	146.1	7-5/16	185.7	6-5/16	160.3	7-5/16	185.7	6-5/16	160.3	6-13/16	173.0
6	7-1/2	190.5	8-1/2	215.9	6-3/4	171.5	8-1/2	215.9	7-1/2	190.5	8-1/2	215.9	7-1/2	190.5	8	203.2
8	9-3/8	238.1	10-5/8	269.9	8-3/4	222.3	10-5/8	269.9	9-3/8	238.1	10-5/8	269.9	9-3/8	238.1	10	254.0
10	11-1/4	285.8	12-3/4	323.9	10-3/4	273.1	12-3/4	323.9	11-1/4	285.8	12-3/4	323.9	11-1/4	285.8	12	304.8
12	13-1/2	342.9	15	381.0	13	330.2	15	381.0	13-1/2	342.9	15	381.0	13-1/2	342.9	14-1/4	362.0
14	14-3/4	374.7	16-1/4	412.8	-	-	-	-	14-3/4	374.7	16-1/4	412.8	14-3/4	374.7	15-1/2	393.7
16	17	425.5	18-1/2	469.9	-	-	-	-	17	425.5	18-1/2	469.9	16-3/4	425.5	17-5/8	447.7
18	19-1/4	489.0	21	533.4	-	-	-	-	19-1/4	489.0	21	533.4	19-1/4	489.0	20-1/8	511.2
20	21	533.4	23	584.2	-	-	-	-	21	533.4	23	584.2	21	533.4	22	558.2
24	25-1/4	641.4	27-1/4	692.2	-	-	-	-	25-1/4	641.4	27-1/4	692.2	25-1/4	641.4	26-1/4	666.8

DIMENSIONS IN INCHES & MILLIMETERS.

*It is essential that Style R gaskets are fitted with a compression stop. Without a correctly dimensioned stop the gasket can easily be over-compressed resulting in failure. To provide a compression stop the depth of the tongue, groove or recess should be controlled to provide optimum compressed gasket thickness with metal to metal contact on the flange faces (see tables on Page 28 and 32).

Note: Style R3 for NPS 1/4 are for class 150 to 600 only. Style R3 for NPS 4-1/2 are for class 150 to 1500 only.

STYLE RIR

FOR USE WITH LARGE MALE & FEMALE ASME B16.5 AND BS 1560 FLANGES

TABLE 17

NOM PIPE SIZE	Style R1 for Large Male and Female									
	Inner Ring		Sealing Element Class 150 - 1500				Sealing Element Class 2500			
	ID		ID	OD		ID	OD		ID	OD
1/4	-	-	1/2	12.7	1	25.4	-	-	-	-
1/2	9/16	14.3	1	25.4	1-3/8	34.9	13/16	20.6	1-3/8	34.9
3/4	13/16	20.6	1-5/16	33.3	1-11/16	42.9	1-1/16	27.0	1-11/16	42.9
1	1-1/16	27.0	1-1/2	38.1	2	50.8	1-1/4	31.8	2	50.8
1-1/4	1-3/8	34.9	1-7/8	47.6	2-1/2	63.5	1-5/8	41.3	2-1/2	63.5
1-1/2	1-5/8	41.3	2-1/8	54.0	2-7/8	73.0	1-7/8	47.6	2-7/8	73.0
2	2-1/16	52.4	2-7/8	73.0	3-5/8	92.1	2-3/8	60.3	3-5/8	92.1
2-1/2	2-1/2	63.5	3-3/8	85.7	4-1/8	104.8	3	76.2	4-1/8	104.8
3	3-1/16	77.8	4-1/4	108.0	5	127.0	3-3/4	95.3	5	127.0
3-1/2	3-9/16	90.5	4-3/4	120.7	5-1/2	139.7	-	-	-	-
4	4-1/16	103.2	5-3/16	131.8	6-3/16	157.2	4-3/4	120.7	6-3/16	157.2
4-1/2	4-9/16	115.9	5-11/16	144.5	6-3/4	171.5	-	-	-	-
5	5-1/16	128.6	6-5/16	160.3	7-5/16	185.7	5-3/4	146.1	7-5/16	185.7
6	6-1/16	154.0	7-1/2	190.5	8-1/2	215.9	6-3/4	171.5	8-1/2	215.9
8	8	203.2	9-3/8	238.1	10-5/8	269.9	8-3/4	222.3	10-5/8	269.9
10	10	254.0	11-1/4	285.8	12-3/4	323.9	10-3/4	273.1	12-3/4	323.9
12	11-15/16	303.2	13-1/2	342.9	15	381.0	13	330.2	15	381.0
14	13-1/2	342.9	14-3/4	374.7	16-1/4	412.8	-	-	-	-
16	15-1/2	393.7	16-3/4	425.5	18-1/2	469.9	-	-	-	-
18	17-1/2	444.5	19-1/4	489.0	21	533.4	-	-	-	-
20	19-1/2	495.3	21	533.4	23	584.2	-	-	-	-
24	23-1/2	596.9	25-1/4	641.4	27-1/4	692.2	-	-	-	-

DIMENSIONS IN INCHES & MILLIMETERS.

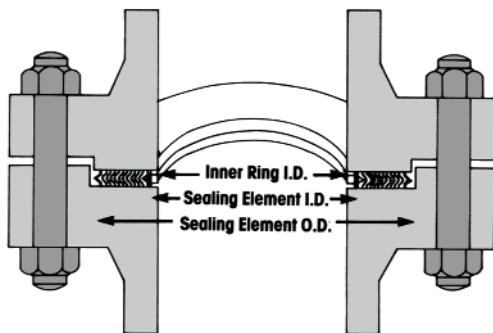

Standard 'RIR' gaskets are manufactured to 0.125" (3.2mm) thickness. The gasket features a solid metal inner ring nominally 0.090" (2.3mm) thick, as an integrated part of its design. The inner ring provides a positive stop preventing the gasket from over compression and possible damage.

Special styles are available in other thickness.

STYLE CG & CGI TO SUIT JIS FLANGES PRESSURE RATING 10Kgf/cm² - 20Kgf/cm²

TABLE 18

Nom. Pipe Size	Inner Ring Inside Dia.	Sealing Element		Centering Ring Outside Dia.
		Inside Dia.	Outside Dia.	
		10	-	
15	-	28	41	57
20	-	34	47	62
25	-	40	53	74
32	-	51	67	84
40	-	57	73	89
50	-	69	89	104
65	-	87	107	124
80	-	98	118	134
90	-	110	130	144
100	-	123	143	159
125	-	148	173	190
150	-	174	199	220
175	-	201	226	245
200	-	227	252	270
225	-	252	277	290
250	-	278	310	332
300	-	329	361	377
350	-	366	406	422
400	-	417	457	484
450	-	468	518	539
500	-	518	568	594
550	-	569	619	650
600	-	620	670	700

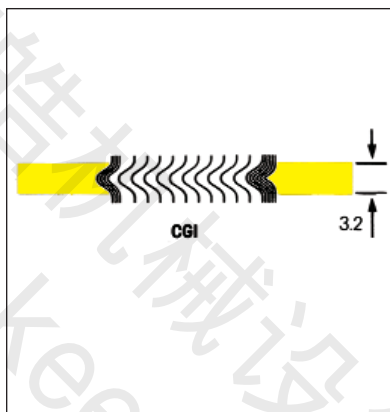
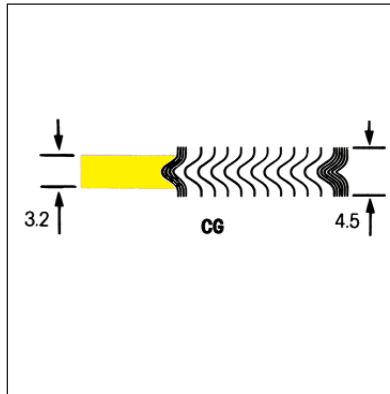

Nom. Pipe Size	Inner Ring Inside Dia.	Sealing Element		Centering Ring Outside Dia.
		Inside Dia.	Outside Dia.	
		10	18	
15	22	28	41	57
20	28	34	47	62
25	34	40	53	74
32	43	51	67	84
40	49	57	73	89
50	61	69	89	104
65	77	87	107	124
80	89	99	119	140
90	102	114	139	150
100	115	127	152	165
125	140	152	177	202
150	166	182	214	237
175	-	-	-	-
200	217	233	265	282
225	-	-	-	-
250	268	288	328	354
300	319	339	379	404
350	356	376	416	450
400	407	432	482	508
450	458	483	533	573
500	508	533	583	628
550	559	584	634	684
600	610	635	685	734

DIMENSIONS IN MILLIMETERS.

STYLE CG & CGI TO SUIT JIS FLANGES PRESSURE RATING 30Kgf/cm² - 63Kgf/cm²

TABLE 19

Nom. Pipe Size	Inner Ring Inside Dia.	Sealing Element		Centering Ring Outside Dia.
		Inside Dia.	Outside Dia.	
		10	18	
15	22	28	41	64
20	28	34	47	69
25	34	40	53	79
32	43	51	67	89
40	49	57	73	100
50	61	69	89	114
65	68	78	98	140
80	80	90	110	150
90	92	102	127	162
100	104	116	141	172
125	128	140	165	207
150	153	165	197	249
200	202	218	250	294
250	251	271	311	360
300	300	320	360	418
350	336	356	396	463
400	383	403	453	524

Nom. Pipe Size	Inner Ring Inside Dia.	Sealing Element		Centering Ring Outside Dia.
		Inside Dia.	Outside Dia.	
		10	15	
15	18	24	37	64
20	23	29	42	69
25	29	35	48	79
32	38	44	60	89
40	43	51	67	100
50	55	63	79	114
65	68	78	98	140
80	80	90	110	150
90	92	102	127	162
100	104	116	141	182
125	128	140	165	224
150	153	165	197	265
200	202	218	250	315
250	251	271	311	378
300	300	320	360	434
350	336	356	396	479
400	383	403	453	531

Nom. Pipe Size	Inner Ring Inside Dia.	Sealing Element		Centering Ring Outside Dia.
		Inside Dia.	Outside Dia.	
		10	15	
15	18	24	37	69
20	23	29	42	75
25	29	35	48	80
32	38	44	60	90
40	43	51	67	107
50	55	63	79	125
65	68	78	98	152
80	80	90	110	162
90	92	102	127	179
100	104	116	141	194
125	128	140	165	235
150	153	165	197	275
200	202	218	250	328
250	251	271	311	394
300	300	320	360	446
350	336	356	396	488
400	383	403	453	545

DIMENSIONS IN MILLIMETERS.

YOUR GLOBAL GASKET PROVIDER

Flexitallic

STYLE CG-RJ & CGI-RJ SPIRAL WOUND GASKETS FOR USE IN ASME B16.5 AND API 6A RING JOINT FLANGES

CG-RJ and CGI-RJ spiral wound gaskets are designed for use, as a replacement maintenance item, of standard oval and octagonal ring joint gaskets. These gaskets are available for NPS 1/2 to 24 and pressure classes 150 to 1500. Gasket thickness is 0.175" (4.5mm) and the outer ring thickness is 0.125" (3.2mm).

Style CGI-RJ gaskets are fitted with an inner ring 0.125 (3.2mm) thick. Flexitallic recommends CGI-RJ gaskets for pressure classes 900 and above, and where operating temperatures are above 572 F (300 C). Consult our technical department for CGI-RJ gasket dimensions.

Note: Clearance dimensions between flange faces should be checked on close coupling pipework prior to installation of CG-RJ and CGI-RJ gaskets to ensure that optimum compression can be achieved without over stressing bolts and or flanges.

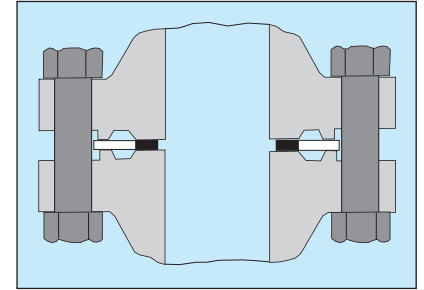

It is the user's responsibility to ensure that there is sufficient clearance between the flange bore and ring groove for proper seating of the gasket.

Dimensions are listed below for CG-RJ spiral wound gaskets. Flexitallic's technical department should be consulted for CGI-RJ and API gasket sizes.

TABLE
20

NOM PIPE SIZE	Pressure Class																	
	150			300			400			600			900			1500		
	Gasket		Ring	Gasket		Ring	Gasket		Ring	Gasket		Ring	Gasket		Ring	Gasket		Ring
	ID	OD	OD	ID	OD	OD	ID	OD	OD	ID	OD	OD	ID	OD	OD	ID	OD	OD
1/2	-	-	-	11/16	1-1/16	2-1/8	11/16	1-1/16	2-1/8	11/16	1-1/16	2-1/8	11/16	1-1/16	2-1/2	11/16	1-1/16	2-1/2
3/4	-	-	-	7/8	1-5/16	2-5/8	7/8	1-5/16	2-5/8	7/8	1-5/16	2-5/8	7/8	1-3/8	2-3/4	7/8	1-3/8	2-3/4
1	1-1/8	1-5/8	2-5/8	1-1/8	1-5/8	2-7/8	1-1/8	1-5/8	2-7/8	1-1/8	1-5/8	2-7/8	1-1/8	1-5/8	3-1/8	1-1/8	1-5/8	3-1/8
1-1/4	1-7/16	1-7/8	3	1-7/16	2	3-1/4	1-7/16	2	3-1/4	1-7/16	2	3-1/4	1-7/16	2	3-1/2	1-7/16	2	3-1/2
1-1/2	1-11/16	2-3/16	3-3/8	1-11/16	2-3/8	3-3/4	1-11/16	2-3/8	3-3/4	1-11/16	2-3/8	3-3/4	1-11/16	2-3/8	3-7/8	1-11/16	2-3/8	3-7/8
2	2-1/8	2-7/8	4-1/8	2-1/8	2-3/4	4-3/8	2-1/8	2-3/4	4-3/8	2-1/8	2-3/4	4-3/8	2-1/4	3-1/4	5-5/8	2-1/4	3-1/4	5-5/8
2-1/2	2-3/4	3-5/16	4-7/8	2-3/4	3-5/16	5-1/8	2-3/4	3-5/16	5-1/8	2-3/4	3-5/16	5-1/8	2-9/16	3-5/8	6-1/2	2-9/16	3-5/8	6-1/2
3	3-5/16	3-15/16	5-3/8	3-5/16	3-15/16	5-7/8	3-5/16	3-15/16	5-7/8	3-5/16	3-15/16	5-7/8	3-3/16	4-3/16	6-5/8	3-3/16	4-11/16	6-7/8
4	4-5/16	5-3/16	6-7/8	4-5/16	5-3/16	7-1/8	4-5/16	5-3/16	7	4-5/16	5-3/16	7-5/8	4-1/4	5-3/16	8-1/8	4-1/4	5-11/16	8-1/4
5	5-5/16	6-3/16	7-3/4	5-5/16	6-7/16	8-1/2	5-5/16	6-7/16	8-3/8	5-5/16	6-7/16	9-1/2	5-5/16	6-7/16	9-3/4	5-1/16	6-15/16	10
6	6-5/16	7-3/16	8-3/4	6-7/16	7-5/8	9-7/8	6-7/16	7-5/8	9-3/4	6-7/16	7-5/8	10-1/2	6-5/16	7-5/8	11-3/8	6-5/16	7-9/16	11-1/8
8	8-1/4	9-3/16	11	8-1/4	9-15/16	12-1/8	8-1/4	9-15/16	12	8-1/4	9-15/16	12-5/8	8-1/4	9-15/16	14-1/8	8-1/8	9-3/4	13-7/8
10	10-5/16	11-7/16	13-3/8	10-5/16	12	14-1/4	10-5/16	12	14-1/8	10-5/16	12	15-3/4	10-5/16	12	17-1/8	10-1/4	11-7/8	17-1/8
12	12-3/16	13-9/16	16-1/8	12-7/8	14-1/4	16-5/8	12-7/8	14-1/4	16-1/2	12-7/8	14-1/4	18	12-7/8	14-1/4	19-5/8	11-15/16	13-13/16	20-1/2
14	13-7/16	14-15/16	17-3/4	14-1/4	15-3/4	19-1/8	14-1/4	15-3/4	19	14-1/4	15-3/4	19-3/8	13-13/16	15-9/16	20-1/2	13-7/16	15-3/16	22-3/4
16	15-1/2	16-15/16	20-1/4	16-1/4	17-3/4	21-1/4	16-1/4	17-3/4	21-1/8	16-1/4	17-3/4	22-1/4	15-9/16	17-9/16	22-5/8	15	17	25-1/4
18	17-1/4	19	21-5/8	18-1/4	20-1/4	23-1/2	18-1/4	20-1/4	23-3/8	18-1/4	20-1/4	24-1/8	17-11/16	19-15/16	25-1/8	17-1/4	19-1/2	27-3/4
20	19-3/4	21-1/8	23-7/8	20-1/4	22-3/16	25-3/4	20-1/4	22-3/16	25-1/2	20-1/4	22-3/16	26-7/8	19-11/16	21-15/16	27-1/2	19-3/16	21-7/16	29-3/4
24	23-1/2	25-1/4	28-1/4	24-1/4	26-5/16	30-1/2	24-1/4	26-5/16	30-1/4	24-1/4	26-5/16	31-1/8	23-3/16	25-15/16	33	23-1/4	25-1/2	35-1/2

DIMENSIONS IN INCHES.

STYLE 625 GASKETS - FOR CLAMP-TYPE AND OTHER NON-STANDARD FLANGE ASSEMBLIES

Style 625 gaskets were originally designed by Flexitallic for clamp-type closures in aircraft, but are now widely used wherever space limitations indicate the need for a wafer-thin or narrow spiral wound gasket.

Style 625 gaskets are manufactured to a nominal thickness of .0625", with compression to .050" - .055".

Style 625 gaskets embody all of the exclusive features of Flexitallic design for keeping compression values in balance with bolting and providing correct resiliency to compensate for variable stresses encountered in service.

Style 625 gaskets can be manufactured from any combination of materials shown on page 5. Please check with Flexitallic for manufacturing limitations on Style 625 gasket larger than 8" I.D. or 3/8" radial width.

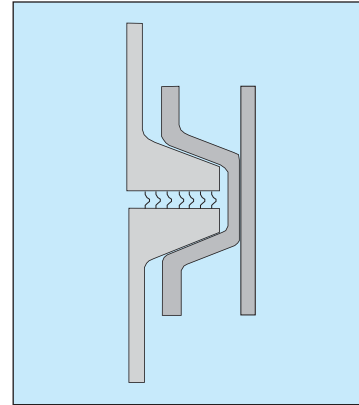

TABLE
21

GASKET I.D. (Inches)	GASKET O.D. (Inches)	GASKET IDENTIFICATION NUMBER	ORIGINAL PART NUMBER
1-1/8	1-5/8	VC-06-1.00	750244-3
1-3/8	1-7/8	VC-06-1.25	750244-4
1-5/8	2-1/8	VC-06-1.50	750244-5
1-7/8	2-3/8	VC-06-1.75	750244-6
2-1/8	2-5/8	VC-06-2.00	750244-7
2-3/8	2-7/8	VC-06-2.25	750244-8
2-5/8	3-1/8	VC-06-2.50	750244-9
2-7/8	3-3/8	VC-06-2.75	750244-10
3-1/8	3-5/8	VC-06-3.00	750244-11
3-1/4	3-3/4	VC-06-3.15	750244-12
3-3/8	3-7/8	VC-06-3.25	750244-13
3-5/8	4-1/8	VC-06-3.50	750244-14
3-7/8	4-3/8	VC-06-3.75	750244-15
4-1/8	4-5/8	VC-06-4.00	750244-16
4-5/8	5-1/8	VC-06-4.50	750244-17
5-1/8	5-5/8	VC-06-5.00	750244-18
5-5/8	6-1/8	VC-06-5.50	750244-19
6-1/8	6-5/8	VC-06-6.00	750244-20

DIMENSIONS IN INCHES.

USEFUL TECHNICAL DATA

ASSEMBLY TECHNIQUES

Gasket Style Selection

Ensure that the correct style of gasket has been selected for the appropriate application.

Note:

See note at bottom of page 8 for inner ring requirements.

All PTFE filled Spiral Wound Gaskets for raised face and flat face flanges should utilize an inner and outer guide ring.

When using Style 'R' Spiral Wound Gaskets ensure that a compression stop is incorporated into the flange arrangement.

Required Gasket Compression

For optimum sealing performance Flexitallic Spiral Wound Gaskets should be compressed to the following thicknesses:

INITIAL GASKET THICKNESS	RECOMMENDED COMPRESSED THICKNESS
0.0625in (1.6mm)	0.050in/0.055in (1.3/1.4mm)
0.100in (2.5mm)	0.075in/0.080in (1.9/2.0mm)
0.125in (3.2mm)	0.090in/0.100in (2.3/2.5mm)
0.175in (4.5mm)	0.125in/0.135in (3.2/3.4mm)
0.250in (6.4mm)	0.180in/0.200in (4.6/5.1mm)
0.285in (7.2mm)	0.200in/0.220in (5.1/5.6mm)

Spiral Wound Gaskets with internal or external guide rings i.e. Style CG and CGI, should be fully compressed to the guide ring. This will not damage the gasket or affect the sealing performance, since the rings are provided as a compression limiting stop.

Flanges

Check that the flange faces are clean, in good condition and with a turned surface finish within the following range Ra 3.2 to 6.3 micrometres (125 to 250 micro inches).

Bolting

Ensure that the correct bolting material is utilized to suit the operating conditions, taking into account the limitation of low yield strength bolts.

Ensure that the use of bolt lubrication is employed. For torque tightening methods Flexitallic recommends the use of molybdenum disulphide bolt lubrication or similar nickel based compound. Do not apply any lubricants when using PTFE coated fasteners. Consult with the coating manufacturers for product specific friction coefficients.

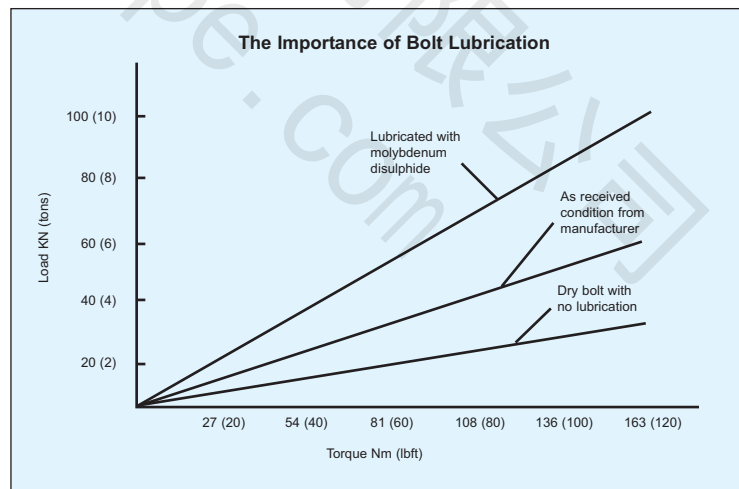
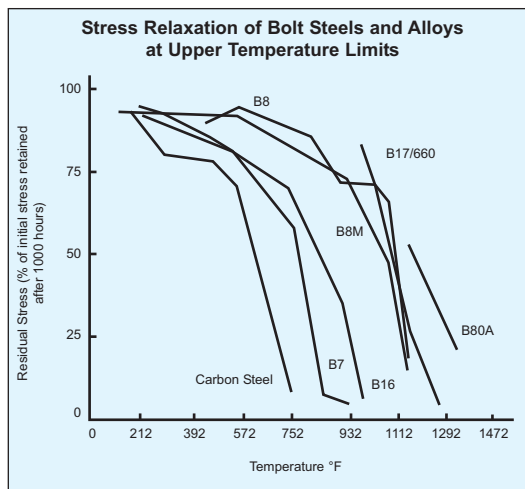

Tightening Procedures

Controlled tightening procedures should be used when installing spiral wound gaskets. Flexitallic recommends that the use of hydraulic tensioning equipment be considered where possible for bolt diameters 1-1/4" and above. Please refer to Flexitallic's Design Criteria for further technical information.

RECOMMENDED TORQUE

Torque Table for CG Spiral Wound Gaskets

TABLE 22

NPS (in.)	Class 150		Class 300		Class 400		Class 600	
	Min Torque	Max Torque	Min Torque	Max Torque	Min Torque	Max Torque	Min Torque	Max Torque
0.5	30	40	30	40	30	40	30	40
0.75	30	40	60	70	60	70	60	70
1	30	40	60	70	60	70	60	70
1.25	30	40	60	70	60	70	60	70
1.5	30	60	100	120	100	120	100	120
2	60	90	60	70	60	70	60	70
2.5	60	110	100	120	100	120	100	120
3	90	120	100	120	100	120	100	120
3.5	60	90	100	120	160	190	170	210
4	70	120	100	140	160	200	190	240
5	100	160	110	160	210	260	280	360
6	130	200	110	160	190	240	260	330
8	180	200	180	260	310	400	400	510
10	170	320	250	290	340	440	500	590
12	240	320	360	420	510	640	500	610
14	300	490	360	420	500	890	680	800
16	310	490	500	590	680	800	800	940
18	500	710	500	680	680	810	1100	1290
20	430	710	500	740	800	940	1100	1290
24	620	1000	800	1030	1500	1750	2000	2340

NPS (in.)	Class 900		Class 1500		Class 2500	
	Min Torque	Max Torque	Min Torque	Max Torque	Min Torque	Max Torque
0.5	70	120	70	100	50	100
0.75	70	120	70	100	70	100
1	110	190	110	160	110	160
1.25	110	190	135	170	210	250
1.5	170	290	200	250	310	360
2	110	190	130	170	220	250
2.5	170	290	190	250	300	360
3	140	230	265	360	460	500
4	255	420	415	520	Not Applicable Use CGI	
5	360	600	585	800		
6	300	500	530	680		
8	485	800	845	1100		
10	505	800	1565	2000		
12	570	850	Not Applicable Use CGI			
14	630	940				
16	910	1290				
18	1570	2340				
20	1745	2570				
24	Not Applicable Use CGI					

Notes:

Torque Values are in ft.-lbs., and assume Alloy Steel Bolts (A193 B7 w/ 2H Nuts) with oil/graphite lubrication.

(Nut factors used on these charts are within .15 to .19)

Flexitallic does not generally recommend a bolt stress above 60,000 PSI.

Torque values limit minimum and maximum gasket seating stresses based upon pressure class and certain operating conditions. (i.e: maximum pressure ratings for given pressure class, not hydrotest pressure), Extreme operating conditions such as high temperature may reduce bolt yield strength. Caution should be used in these applications. The above torque values are for general use only. For critical or extreme applications (high temperature/pressure) consult with Flexitallic engineering.

Flexitallic does not accept responsibility for the misuse of this information.

RECOMMENDED TORQUE

Torque Table for CGI Spiral Wound Gaskets

TABLE
23

NPS (in.)	Class 150		Class 300		Class 400		Class 600	
	Min Torque	Max Torque	Min Torque	Max Torque	Min Torque	Max Torque	Min Torque	Max Torque
0.5	30	50	30	40	30	40	30	40
0.75	30	50	60	80	60	80	60	80
1	30	60	60	80	60	80	60	80
1.25	30	60	60	80	60	80	60	80
1.5	30	60	100	140	100	140	100	140
2	60	120	60	80	60	80	60	80
2.5	60	120	100	140	100	140	100	140
3	90	120	100	150	100	150	100	150
3.5	60	120	100	170	160	290	170	290
4	70	120	100	200	160	320	190	320
5	100	200	110	200	210	320	280	490
6	130	200	110	200	190	320	260	460
8	180	200	180	320	310	490	400	700
10	170	320	250	460	360	710	500	800
12	240	320	360	700	510	1000	500	850
14	300	490	360	610	500	870	680	950
16	310	490	500	920	680	1250	800	1210
18	490	710	500	1000	680	1340	1100	1790
20	430	710	500	1000	800	1430	1100	1640
24	620	1000	800	1600	1500	2270	2000	2670

NPS (in.)	Class 900		Class 1500		Class 2500	
	Min Torque	Max Torque	Min Torque	Max Torque	Min Torque	Max Torque
0.5	70	120	70	100	50	100
0.75	70	120	70	100	63	100
1	110	190	110	160	110	160
1.25	110	190	140	164	210	250
1.5	170	290	200	250	310	360
2	110	190	130	170	220	250
2.5	170	290	190	250	300	360
3	140	230	270	360	460	500
4	260	420	420	520	710	800
5	360	600	590	800	1280	1500
6	300	500	530	680	1870	2200
8	485	800	850	1100	1780	2200
10	505	800	1570	2000	3040	4400
12	560	850	1500	2200	4610	5920
14	630	940	2120	3180		
16	910	1290	2940	4400		
18	1570	2340	3950	5920		
20	1745	2570	5150	7720		
24	2945	5140	8340	12500		

Notes:

Torque Values are in ft.-lbs., and assume Alloy Steel Bolts (A193 B7 w/ 2H Nuts) with oil/graphite lubrication. (Nut factors used on these charts are within .15 to .19)

Flexitallic does not generally recommend a bolt stress above 60,000 PSI.

Torque values limit minimum and maximum gasket seating stresses based upon pressure class and certain operating conditions. (i.e: maximum pressure ratings for given pressure class, not hydrotest pressure), Extreme operating conditions such as high temperature may reduce bolt yield strength. Caution should be used in these applications. The above torque values are for general use only. For critical or extreme applications (high temperature/pressure) consult with Flexitallic engineering.

Flexitallic does not accept responsibility for the misuse of this information.

BOLTING DATA FOR ASME B16.5 & BS 1560 FLANGES

TABLE 24

NOM PIPE SIZE	CLASS 150				CLASS 300				CLASS 400				CLASS 600			
	FLANGE DIA.	NO. OF BOLTS	BOLT DIA.	B.C. DIA.	FLANGE DIA.	NO. OF BOLTS	BOLT DIA.	B.C. DIA.	FLANGE DIA.	NO. OF BOLTS	BOLT DIA.	B.C. DIA.	FLANGE DIA.	NO. OF BOLTS	BOLT DIA.	B.C. DIA.
1/4	3-3/8	4	1/2	2-1/4	3-3/8	4	1/2	2-1/4	3-3/8	4	1/2	2-1/4	3-3/8	4	1/2	2-1/4
1/2	3-1/2	4	1/2	2-3/8	3-3/4	4	1/2	2-5/8	3-3/4	4	1/2	2-5/8	3-3/4	4	1/2	2-5/8
3/4	3-7/8	4	1/2	2-3/4	4-5/8	4	5/8	3-1/4	4-5/8	4	5/8	3-1/4	4-5/8	4	5/8	3-1/4
1	4-1/4	4	1/2	3-1/8	4-7/8	4	5/8	3-1/2	4-7/8	4	5/8	3-1/2	4-7/8	4	5/8	3-1/2
1-1/4	4-5/8	4	1/2	3-1/2	5-1/4	4	5/8	3-7/8	5-1/4	4	5/8	3-7/8	5-1/4	4	5/8	3-7/8
1-1/2	5	4	1/2	3-7/8	6-1/8	4	3/4	4-1/2	6-1/8	4	3/4	4-1/2	6-1/8	4	3/4	4-1/2
2	6	4	5/8	4-3/4	6-1/2	8	5/8	5	6-1/2	8	5/8	5	6-1/2	8	5/8	5
2-1/2	7	4	5/8	5-1/2	7-1/2	8	3/4	5-7/8	7-1/2	8	3/4	5-7/8	7-1/2	8	3/4	5-7/8
3	7-1/2	4	5/8	6	8-1/4	8	3/4	6-5/8	8-1/4	8	3/4	6-5/8	8-1/4	8	3/4	6-5/8
3-1/2	8-1/2	8	5/8	7	9	8	3/4	7-1/4	9	8	7/8	7-1/4	9	8	7/8	7-1/4
4	9	8	5/8	7-1/2	10	8	3/4	7-7/8	10	8	7/8	7-7/8	10-3/4	8	7/8	8-1/2
5	10	8	3/4	8-1/2	11	8	3/4	9-1/4	11	8	7/8	9-1/4	13	8	1	10-1/2
6	11	8	3/4	9-1/2	12-1/2	12	3/4	10-5/8	12-1/2	12	7/8	10-5/8	14	12	1	11-1/2
8	13-1/2	8	3/4	11-3/4	15	12	7/8	13	15	12	1	13	16-1/2	12	1-1/8	13-3/4
10	16	12	7/8	14-1/4	17-1/2	16	1	15-1/4	17-1/2	16	1-1/8	15-1/4	20	16	1-1/4	17
12	19	12	7/8	17	20-1/2	16	1-1/8	17 3/4	20-1/2	16	1-1/4	17-3/4	22	20	1-1/4	19-1/4
14	21	12	1	18-3/4	23	20	1-1/8	20-1/4	23	20	1-1/4	20-1/4	23-3/4	20	1-3/8	20-3/4
16	23-1/2	16	1	21-1/4	25-1/2	20	1-1/4	22-1/2	25-1/2	20	1-3/8	22-1/2	27	20	1-1/2	23-3/4
18	25	16	1-1/8	22-3/4	28	24	1-1/4	24-3/4	28	24	1-3/8	24-3/4	29-1/4	20	1-5/8	25-3/4
20	27-1/2	20	1-1/8	25	30-1/2	24	1-1/4	27	30-1/2	24	1-1/2	27	32	24	1-5/8	28-1/2
24	32	20	1-1/4	29-1/2	36	24	1-1/2	32	36	24	1-3/4	32	37	24	1-7/8	33

DIMENSIONS IN INCHES.

TABLE 24.1

NOM PIPE SIZE	CLASS 900				CLASS 1500				CLASS 2500			
	FLANGE DIA.	NO. OF BOLTS	BOLT DIA.	B.C. DIA.	FLANGE DIA.	NO. OF BOLTS	BOLT DIA.	B.C. DIA.	FLANGE DIA.	NO. OF BOLTS	BOLT DIA.	B.C. DIA.
1/2	4-3/4	4	3/4	3-1/4	4-3/4	4	3/4	3-1/4	5-1/4	4	3/4	3-1/2
3/4	5-1/8	4	3/4	3-1/2	5-1/8	4	3/4	3-1/2	5-1/2	4	3/4	3-3/4
1	5-7/8	4	7/8	4	5-7/8	4	7/8	4	6-1/4	4	7/8	4-1/4
1-1/4	6-1/4	4	7/8	4-3/8	6-1/4	4	7/8	4-3/8	7-1/4	4	1	5-1/8
1-1/2	7	4	1	4-7/8	7	4	1	4-7/8	8	4	1-1/8	5-3/4
2	8-1/2	8	7/8	6-1/2	8-1/2	8	7/8	6-1/2	9-1/4	8	1	6-3/4
2-1/2	9-5/8	8	1	7-1/2	9-5/8	8	1	7-1/2	10-1/2	8	1-1/8	7-3/4
3	9-1/2	8	7/8	7-1/2	10-1/2	8	1-1/8	8	12	8	1-1/4	9
4	11-1/2	8	1-1/8	9-1/4	12-1/4	8	1-1/4	9-1/2	14	8	1-1/2	10-3/4
5	13-3/4	8	1-1/4	11	14-3/4	8	1-1/2	11-1/2	16-1/2	8	1-3/4	12-3/4
6	15	12	1-1/8	12-1/2	15-1/2	12	1-3/8	12-1/2	19	8	2	14-1/2
8	18-1/2	12	1-3/8	15-1/2	19	12	1-5/8	15-1/2	21-3/4	12	2	17-1/4
10	21-1/2	16	1-3/8	18-1/2	23	12	1 7/8	19	26-1/2	12	2-1/2	21-1/4
12	24	20	1-3/8	21	26-1/2	16	2	22-1/2	30	12	2-3/4	24-3/8
14	25-1/4	20	1-1/2	22	29-1/2	16	2-1/4	25	-	-	-	-
16	27-3/4	20	1-5/8	24-1/4	32-1/2	16	2-1/2	27-3/4	-	-	-	-
18	31	20	1-7/8	27	36	16	2-3/4	30-1/2	-	-	-	-
20	33-3/4	20	2	29-1/2	38-3/4	16	3	32-3/4	-	-	-	-
24	41	20	2-1/2	35-1/2	46	16	3-1/2	39	-	-	-	-

DIMENSIONS IN INCHES.

FACING DIMENSIONS FOR ASME B16.5 & BS 1560 FLANGES

CLASS 150, 300, 400, 600, 900, 1500 AND 2500

**TABLE
25**

NOM PIPE SIZE	OUTSIDE DIAMETER See Note 3			I.D. OF LARGE & SMALL TONGUE See Notes 3 & 5 U	OUTSIDE DIAMETER See Note 3			I.D. OF LARGE & SMALL GROOVE See Note 3 See Note 5 Z	HEIGHT		DEPTH OF GROOVE OR FEMALE
	RAISED FACE, LAPPED, LARGE MALE, & LARGE TONGUES See Note 5 R	SMALL MALE See Notes 4&5 S	SMALL TONGUE See Note 5 T		LARGE FEMALE & LARGE GROOVE See Note 5 w	SMALL FEMALE See Note 4 See Note 5 X	SMALL GROOVE See Note 5 V		RAISED FACE CLASS 150 & 300 See Note 1	RAISED FACE LARGE & SMALL MALE & TONGUE CLASS 400, 600, 900 1500 & 2500 See Note 2	
1/2	1-3/8	22/32	1-3/8	1	1-7/16	25/32	1-7/16	15/16	1/16	1/4	3/16
3/4	1-11/16	15/16	1-11/16	1-5/16	1-3/4	1	1-3/4	1-1/4	1/16	1/4	3/16
1	2	1-3/16	1-7/8	1-1/2	2-1/16	1-1/4	1-15/16	1-7/16	1/16	1/4	3/16
1-1/4	2-1/2	1-1/2	2-1/4	1-7/8	2-9/16	1-9/16	2-5/16	1-13/16	1/16	1/4	3/16
1-1/2	2-7/8	1-3/4	2-1/2	2-1/8	2-15/16	1-13/16	2-9/16	2-1/16	1/16	1/4	3/16
2	3-5/8	2-1/4	3-1/4	2-7/8	3-11/16	2-5/16	3-5/16	2-13/16	1/16	1/4	3/16
2-1/2	4-1/8	2-11/16	3-3/4	3-3/8	4-3/16	2-3/4	3-13/16	3-5/16	1/16	1/4	3/16
3	5	3-5/16	4-5/8	4-1/4	5-1/16	3-3/8	4-11/16	4-3/16	1/16	1/4	3/16
3-1/2	5-1/2	3-13/16	5-1/8	4-3/4	5-9/16	3-7/8	5-3/16	4-11/16	1/16	1/4	3/16
4	6-3/16	4-5/16	5-11/16	5-3/16	6-1/4	4-3/8	5-3/4	5-1/8	1/16	1/4	3/16
5	7-5/16	5-3/8	6-13/16	6-5/16	7-3/8	5-7/16	6-7/8	6-1/4	1/16	1/4	3/16
6	8-1/2	6-3/8	8	7-1/2	8-9/16	6-7/16	8-1/16	7-7/16	1/16	1/4	3/16
8	10-5/8	8-3/8	10	9-3/8	10-11/16	8-7/16	10-1/16	9-5/16	1/16	1/4	3/16
10	12-3/4	10-1/2	12	11-1/4	12-13/16	10-9/16	12-1/16	11-3/16	1/16	1/4	3/16
12	15	12-1/2	14-1/4	13-1/2	15-1/16	12-9/16	14-5/16	13-7/16	1/16	1/4	3/16
14	16-1/4	13-3/4	15-1/2	14-3/4	16-5/16	13-13/16	15-9/16	14-1/16	1/16	1/4	3/16
16	18-1/2	15-3/4	17-5/8	16-3/4	18-9/16	15-13/16	17-11/16	16-11/16	1/16	1/4	3/16
18	21	17-3/4	20-1/8	19-1/4	21-1/16	17-13/16	20-3/16	19-3/16	1/16	1/4	3/16
20	23	19-3/4	22	21	23-1/16	19-13/16	22-1/16	20-15/16	1/16	1/4	3/16
24	27-1/4	23-3/4	26-1/4	25-1/4	27-5/16	23-13/16	26-5/16	25-3/16	1/16	1/4	3/16

DIMENSIONS IN INCHES.

NOTES

1. Regular facing for class 150 and 300 steel flanged fittings and companion flange standards is a 1/16" raised face included in the minimum flange thickness dimensions. A 1/16" raised face may be supplied also on the class 400, 600, 900, 1500, and 2500 flange standards, but it must be added to the minimum flange thickness.
2. Regular facing for class 400, 600, 900, 1500, and 2500 flange thickness dimensions.
3. Tolerance of plus or minus 0.016 in. (1/64") is allowed on the inside and outside diameters of all facings.
4. For small male and female joints care should be taken in the use of these dimensions to insure that pipe used is thick

5. Gaskets for male-female and tongue-groove joints shall cover the bottom of the recess with minimum clearances taking into account the tolerances prescribed in Note 3.
- enough to permit sufficient bearing surface to prevent the crushing of the gasket. The dimensions apply particularly on lines where the joint is made on the end of the pipe. Screwed companion flanges for small male and female joints are furnished with plain face and are threaded with American Standard Locknut Thread.

SPECIAL APPLICATION GASKETS

HEAT EXCHANGER GASKETS

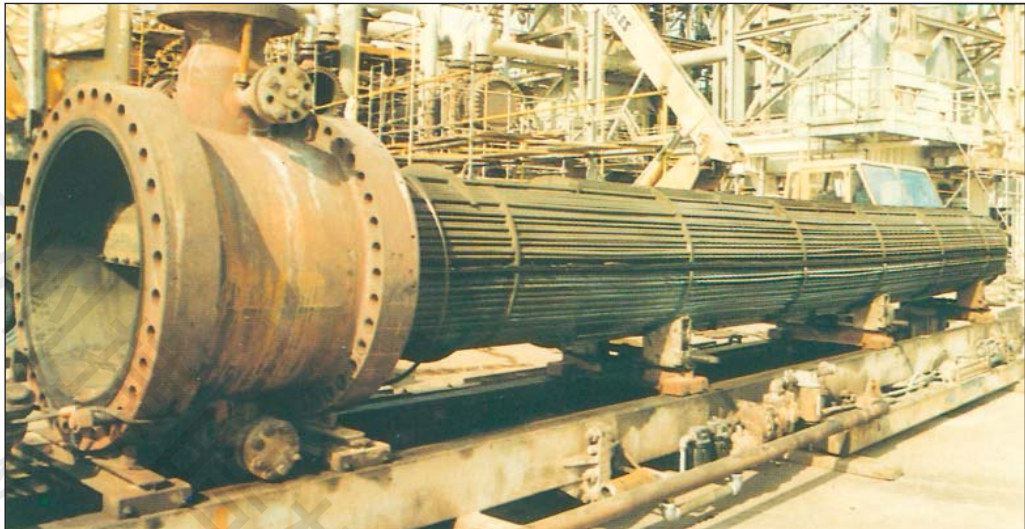

Special HE-CGI Gaskets With Spiral Wound Outer Ring (ALTERNATIVES HE-CG, HE-CGI)

Flexitallic special HE-CGI Gaskets with spiral wound outer ring are primarily designed for TEMA male and female flanges and are custom built to suit the design conditions of individual heat exchanger vessels. These gaskets are available in an extensive range of materials.

This style incorporates several special features, as follows:

1. The outer wound nose to ensure correct sealing element location in the flange recess.
2. A spiral wound sealing element to ensure a positive seal under fluctuating temperature and pressure conditions.
3. A solid metal inner ring to protect the sealing element and act as a compression stop. As an optional extra, inner rings can also be supplied with nylon location screws to secure the gasket to the flange on assembly.
4. Can be supplied with pass partition bars in any configuration. Pass bars are secured to the inner ring and can be supplied in either solid metal or double jacketed construction.

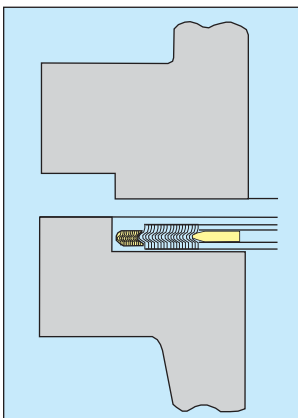

Style HE-CG

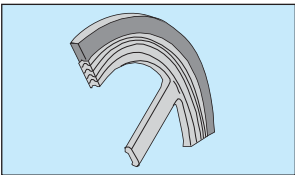

Style HE-CGI

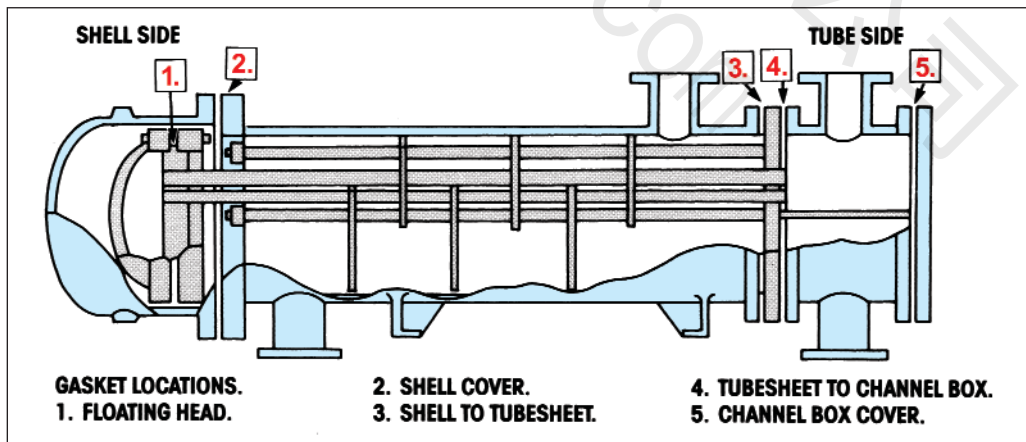
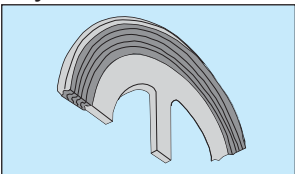

Heat exchangers with flat face or raised face flanges should utilize style CG and CGI spiral wound gaskets.

CARRIER RING GASKETS

The carrier ring concept consists of a solid metal ring with a machined recess in each face. Spiral wound gaskets are then located in each of the machined recesses.

This type of arrangement has been successfully used in sealing problematic flanges and vessels in the nuclear, power and petrochemical industries. The major benefits of the carrier ring assembly are due to the double spiral wound gasket being present. This results in a very high recovery gasket, ensuring that the bolt load is maintained on the sealing elements when arduous pressure/temperature cycling occurs in service, thus maintaining a seal.

Carrier rings can be used on flat face, raised face or tongue and groove type flange, as well as non standard flange configurations. They can be supplied for both small and large diameter nominal bores up to class 2500 pressure rating. Carrier rings are also tailor made to suit specific flange arrangements and design conditions.



Typical Applications

The carrier ring concept has been extensively used in the power generation industries, petrochemical and nuclear industries. Typical applications are as follows:

Heat Exchanger

Operating Pressure: 2900 psi

Temperature: 200°C

Tube Sheet

H.P. Heaters, Fossil Fired Generators,

H.O.T. Construction, Steam Service

Operating Pressure: 700 psi

Temperature: 370°C

Materials Utilized

316L/Flexicarb®

17-7PH/Flexicarb®

Inc X750 HT (Special high recovery material)

Catalytic Crackers

720°C, Regenerators, 2980 mm OD

Hydrocarbon Service, Refineries

STYLE LS™ & LSI LOW STRESS RANGE OF SPIRAL WOUND GASKETS

The LS gasket offers the same high integrity seal associated with the spiral wound gasket however, the LS and LSI has been designed in such a way that compression and sealing requirements are achieved under very low seating stresses. These gaskets are intended for use on class 150 and 300 applications, where customers traditionally do not use spiral wound gaskets due to concerns about exceeding allowable design stresses.

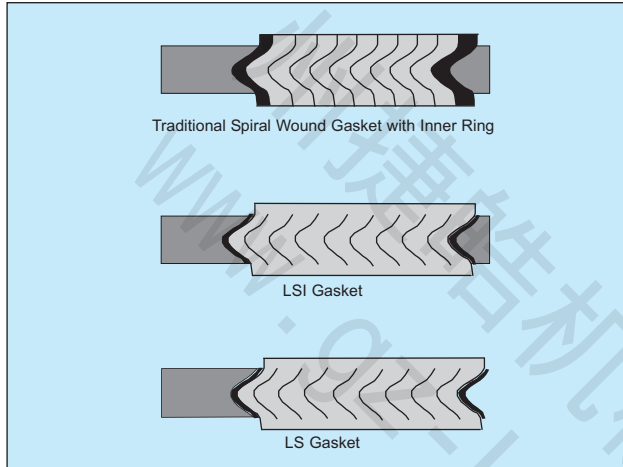

The traditional spiral wound gasket has its steel windings protruding above the compression stop; this requires a significant loading stress to compress the gasket to its optimum operating thickness. The LS and LSI gaskets have only soft Flexicarb® or PTFE filler protruding above metal windings and guide ring; therefore as the gasket is compressed, the Flexicarb® or PTFE filler is readily compressed thus producing the sealing mechanism at an earlier stage as compared to the conventionally manufactured spiral wound gasket.

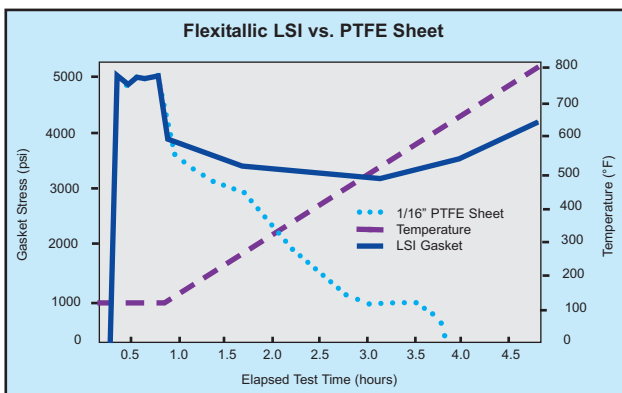

The "LSI" gasket retains more of its initial stress or tightness, even when subjected to high temperatures, unlike PTFE sheet gaskets.

AVAILABLE IN A VARIETY OF METALS, ENGINEERED TO SUIT SPECIFIC APPLICATIONS.

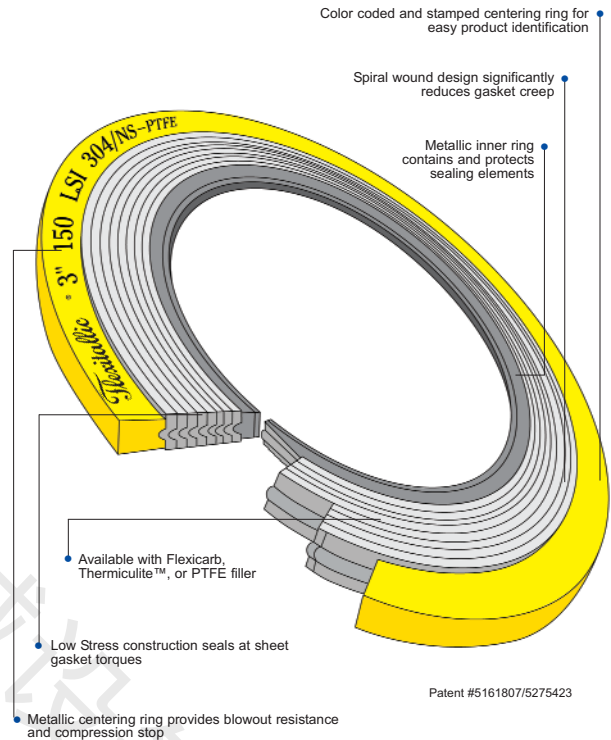

LOWER BOLT STRESS-REDUCED FUGITIVE EMISSIONS			
Flexitallic recommended minimum bolt torque figures for use with the "LSI" gasket on ASME/B16.5 flanges.*			
NPS (IN.)	TORQUE FT.LBS.	NPS (IN.)	TORQUE FT.LBS.
1/2	25	5	83
3/4	25	6	83
1	25	8	83
1 1/4	25	10	133
1 1/2	25	12	133
2	50	14	204
2 1/2	50	16	204
3	50	18	295
3 1/2	50	20	296
4	50	24	417

NOTE: MINIMUM REQUIRED TORQUES MAY BE EVEN LOWER DEPENDING ON GASKET SIZE AND BOLT MATERIALS. PLEASE CONTACT FLEXITALLIC'S TECHNICAL DEPARTMENT FOR MORE INFORMATION.

*Above torque values are for class 150 ASME flanges.
TORQUE VALUES FOR 300# AVAILABLE ON REQUEST.

SPIRAL WOUND GASKETS FOR BOILER CAP AND MANHOLE COVER ASSEMBLIES

Gaskets for boiler handhole, tubecap and manhole covers incorporating the unique Flexitallic Spiral Wound profile and specially manufactured with Flexicarb® filler, are ideal for corrosive, high pressure or temperature duties. Flexitallic's anticipation of developments in modern steam generating and engineering equipment and ability to design to specific requirements are the guarantee of the perfect seal at minimum maintenance cost with consistently high standards of performance.

- High safety factor related to specific operating conditions
- Compression loadings proportional to safe stresses of cover assemblies
- Resilient under concentrated and fluctuating loads
- Prolonged trouble-free service
- Reduced seat cleaning time



Standard Style M

Style M & MC & MCS

Spiral Wound Gaskets for Boiler Manhole Cover Assemblies

The Flexitallic manhole gasket spiral constructions incorporate modified compression values to provide seating loads within the normal range of cover assemblies.

Size/Range Specification

Available in circular, obround, and oval shapes to suit standard manhole plate configurations.



Style M Gaskets



Style MC Gaskets

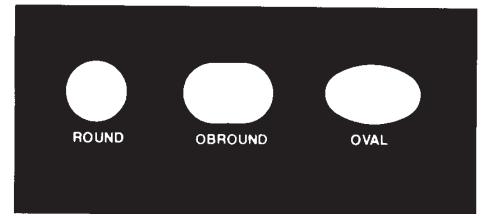

Style T Pear

Style T

Spiral Wound Gaskets for Boiler Handhole and Tubecap Assemblies

The design features of the basic Flexitallic spiral wound construction alleviate the need for sealing compound. Particularly suitable where old and pitted faces have rendered other gaskets ineffective.

Size/Range Specification

Available in several standard shapes:-



Basic spiral construction of Style T Gaskets

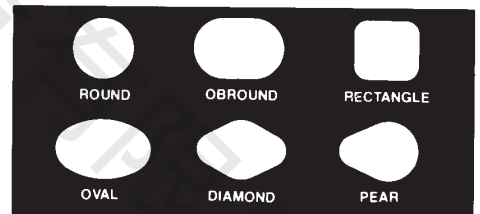

Supplied in thicknesses of 3.2mm (0.125in.) or 4.5mm (0.175 in.). The standard thickness of 4.5mm (0.175in.) is recommended for use in assemblies where the seat is relatively broad and bolting load is low.

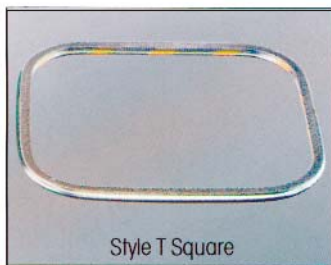

Style T Square

Materials

Standard materials are Type 304 Stainless Steel and Flexicarb windings. Special materials to suit specific operating conditions are available.

To Order

With all orders or inquiries please submit following:

- a) Name of boiler or equipment manufacturer
- b) Gasket style
- c) Dimensions of gasket
- d) Gasket thickness
- e) Flange width of gasket
- f) Pressure service rating
- g) Gasket material preference

STYLES M & MC FOR MANHOLE COVER ASSEMBLIES

TABLE
26

Style M

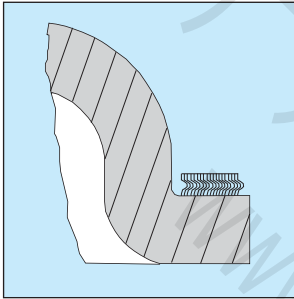

Style MC

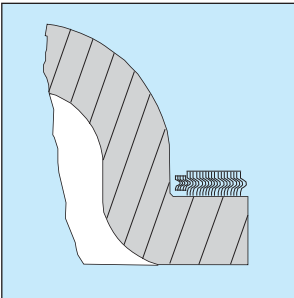

STYLE	NOMINAL I.D. DIMENSIONS (inches)	THICKNESS (inches)	FLANGE WIDTH (inches)
M-Oval	10 x 15	.250	15/16
M-Oval	10 x 16	.250	15/16
M-Oval	11 x 15	.250	15/16
MC-Oval	11 x 15	.250	13/16
M-Oval	11 x 15	.175	3/4
M-Oval	11 x 15	.175	15/16
M-Oval	11 x 15	.175	1/2
M-Oval	11 x 15	.175	11/4
M-Oval	11 x 15	.250	11/4
M-Obround	11-1/16 x 14-7/8	.250	15/16
M-Obround	11-7/16 x 15-1/16	.250	15/16
M-Oval	12 x 16	.250	15/16
MC-Oval	12 x 16	.250	13/16
M-Oval	12 x 16	.175	1/2
M-Oval	12 x 16	.175	3/4
M-Oval	12 x 16	.175	15/16
M-Oval	12 x 16	.175	1-1/4
M-Oval	12 x 16	.250	1-1/4
M-Obround	12 x 16	.250	15/16
M-Obround	12 x 16	.250	1-1/4
MC-Oval	12-1/8 x 16-1/8	.250	13/16
M-Obround	14 x 16	.175	3/4
M-Round	14	.175	3/4
M-Round	16-1/16	.175	3/4

NOTE: When ordering gaskets specify operating pressure and temperature and type of steel desired.

FLEXITALLIC STYLE MCS SPIRAL WOUND GASKETS

In keeping with our tradition of taking a leadership role in the gasket industry we are pleased to introduce the Flexitallic style MCS spiral wound gasket for use on boiler manhole cover assemblies. The style MCS gasket is an exclusive Flexitallic design, consisting of a Flexitallic spiral wound gasket with an integral solid metal inner and/or outer ring. The spiral wound sealing element provides resilience, strength, blowout resistance and superior sealability. The solid metal rings prevent over-compression of the gasket, which is especially important on high pressure boilers. In addition, the rings provide stability and facilitate proper positioning of the gasket on the cover which prevents pinching, shouldering, and other gasket damage resulting from misalignment, irregular plate contours and fillets.

Flexitallic style MCS spiral wound gaskets are available in a wide range of materials for standard, as well as special design manhole cover assemblies, in pressure classes of 0-499 psi, 0-999 psi, and 1000 psi and higher. For additional information on Flexitallic style MCS spiral wound gaskets, contact the Flexitallic plant nearest you.

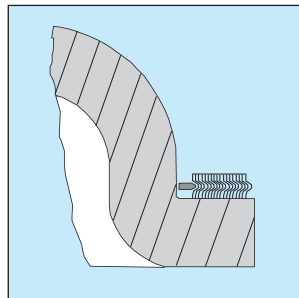

Style MCS

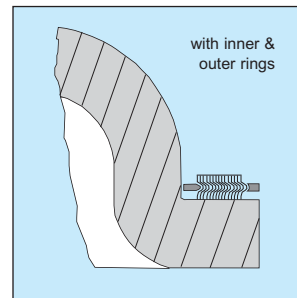

Style MCS
with inner & outer rings

STYLE T FOR BOILER HANDHOLE AND TUBECAP ASSEMBLIES

0-499 lbs, 0-999 lbs, 1000 lbs and above. Specify operating temperature, pressure and type of steel.

TABLE 27	IDENTIFICATION	SHAPE	NOMINAL I.D. (inches)	FLANGE WIDTH (inches)	IDENTIFICATION	SHAPE	NOMINAL I.D. (inches)	FLANGE WIDTH (inches)
	American Engineering	Obround Round	3-5/16 x 3-11/16 3-5/16	3/16 3/16	Foster Wheeler (cont.)	Round Round Rect.	3-1/8 or 3-1/16 4-1/8 or 4-1/16 4-15/16 x 5-3/16	3/8 3/8 7/32
	Babcock and Wilcox No.41 No.40 No.48 No.79 No.24 No.76 2" Econ. No.47 No.32 No.70 No.89 No.92 No.28	Obround Diamond Oval Obround Oval Round Round Round Round Round Round Rect.	2-9/64 x 2-33/64 3-3/8 x 3-3/4 3-13/16 x 4-3/4 4-5/32 x 4-25/32 4-1/2 x 5-1/2 5-1/32 x 5-31/32 1-5/8 2-1/32 3 3-9/32 3-7/16 4-1/32 4-13/16 x 5	5/32 3/16 7/32 1/4 7/32 1/4 3/16 1/4 3/16 5/32 1/4 7/32	Geary 31/2" 4" 4" (.285" Thick)	Obround Obround Obround	3-13/16 x 4-5/8 4-1/4 x 5-1/4 4-1/4 x 5 1/4	3/8 7/16 7/16
	Badenhausen (See Riley Stoker)				Heine	Obround Round	3-5/8 x 4-5/8 3-5/8	3/8 3/8
	Bros HB-5 and HB-10 HB-6 and HB-11 HB-12 HB-8 and HB-13 HB-14	Round Round Round Obround Obround	2-1/4 3-3/8 4-1/4 3-3/8 x 4-1/4 4-1/4 x 5	1/4 1/4 1/4 1/4 1/4	International	Oval	2-19/32 x 3-19/32	7/16
	Bucyrus-Erie Q227 0260 0208	Obround Oval Round	3 x 4-1/2 4 x 6 2-1/2	3/8 7/16 1/4	Keeler	Diamond Round Obround	4-1/4 x 5-1/4 4-1/4 3 x 4	3/8 3/8 3/8
	Casey-Hedges	Obround	4-1/4 x 5-1/8	3/8	Murray	Obround Obround Obround	3-5/8 x 4-9/16 3-5/8 x 4-9/16 4-1/32 X 4-29/32	3/8 7/16 3/8
	Cleaver-Brooks	Obround Obround Obround	2-27/32 x 3-19/32 3-9/32 x 4-17/32 4 x 6	5/16 3/8 3/8	Oil Field	Obround Oval Oval Oval	2-1/2 x 3-1/2 3 x 4 3-1/2 x 4-1/2 4-1/16 x 5-1/16	3/8 3/8 3/8 7/16
	Combustion Engineering 24N-L1206 29N-L839 30N-L866 33N-L1205 31N-L579 21N-L1291 22N 23N 25N-L1 278 27N 28N-L1277 32N 1N-L1272 7N-L1131 3N-L1274 4N-L740 L741 5N-L902 5N-L744 51N 52N-L1117 PB9474 PB9474	Diamond Diamond Diamond Diamond Diamond Obround Oval Obround Obround Diamond Obround Oval Round Round Round Round Round Round Round Round Round Rect. Rect. Obround Round	3 x 3-7/8 3-3/8 x 4-1/4 3-5/8 x 4-1/2 3-3/4 x 4-5/8 4-1/4 x 5-1/8 2-1/8 x 2-1/2 2-1/8 x 2-5/8 2-25/32 x 3-13/32 3-1/8 x 4-1/8 3-3/8 x 3-3/4 3-3/8 x 3-7/8 4-1/2 x 5-1/2 1-1/2 1-3/4 2-5/8 3-1/8 3-3/8 3-5/8 4-1/8 4-13/16 x 5 4-7/8 x 5-3/16 4-1/8 x 4-7/8 3-1/2	1/4 1/4 1/4 1/4 1/4 5/32 7/32 7/32 3/16 3/16 3/16 7/32 3/16 3/16 7/32 1/4 1/4 1/4 1/4 1/4 1/4 1/4 7/32 7/32 3/16 3/16 3/16 1/4 1/4 1/4 1/4 1/4 1/4 1/4 1/4 3/16 3/16	Pacific	Round Round Round	1-1/2 2 2-1/2	1/2 1/2 1/2
	Connelly	Obround	3 x 3-15/16	3/8	Page Larrabee Junior Page P-B Drum Consol	Oval Oval Oval Oval Oval Oval	2-27/32 x 3-29/32 3-1/8 x 4-1/8 3-1/8 x 4-1/4 3-5/16 x 4-5/16 3-25/32 x 5-13/32 2-3/16	3/8 3/8 3/8 3/8 5/8 3/8
	Edge Moor	Oval Round Round	4-1/8 x 5-1/4 2-1/2 4-1/16	3/8 1/2 15/32	Riley Stoker W-C22 W-C2 W-C16 W-C6 W-C9	Oval Obround Round Round Square Square	3-17/32 x 4-17/32 3-23/32 x 5-23/32 1-31/32 3-9/32 4 x 4 5-1/2 x 5-1/2	5/16 11/32 3/8 5/16 11/32 3/8
	Erie City	Pear Obround Oval Oval Oval Oval Round	3-1/2 x 4-5/8 3 x 4-1/2 3-1/32 x 4-1/32 3-17/32 x 4-17/32 4-1/32 x 5-1/32 4-1/32 x 6-1/32 3-1/2	3/8 3/8 5/16 5/16 5/16 3/8 3/8	Springfield	Oval Oval Square Square	3-17/32 x 4-17/32 4-1/16 x 5-1/16 5-1/2 x 5-1/2 7-3/8 x 7-3/8	5/16 3/8 3/8 5/8
	Foster Wheeler 23/4" 315/16"	Diamond Obround Obround Obround Round Round Round Round	4 x 5 2-25/32 x 3-13/32 3 x 4 3-11/32 x 3-31/32 4-3/16 x 5-3/16 15/16 2-1/32 2-1/32 2-1/8 or 2-1/16	3/8 7/32 3/8 7/32 5/16 5/32 13/64 15/64 3/8	Superheater	Obround Obround Obround Obround Round Round	2-21/32 x 3-9/32 3-3/32 x 4-3/32 3-11/32 x 3-23/32 3-3/8 x 3-3/8 15/16 3-3/32	15/64 1/4 3/16 1/4 3/16 1/4
					Union 3 1/4" (.285" Thick)	Pear Pear Pear Pear Oval Oval	3-7/16 x 4-7/16 3-1/2 x 4-1/2 4-1/4 x 5-1/4 4-1/4 x 5-1/4 3-1/2 x 4-1/2 3 x 4	3/8 3/8 3/8 3/8 3/8 3/8
					Vogt	Oval Oval Oval Oval Oval Oval Oval Oval Round Round	3 x 4 3-3/8 x 4-1/4 3-1/4 x 4-1/2 3-3/4 x 5 4 x 5 4 x 6 4-1/4 x 5-1/8 4-1/4 x 5-1/8 4-9/32 X 5-5/32 3-19/32 4-1/8	5/16 7/32 5/16 3/8 5/16 3/8 7/32 5/16 (old) 7/32 3/8 3/8
					Ward Wickes D2300 D2301 D2361 D2724	Square Pear Pear Oval Oval Oval Oval Round Round	4-7/8 x 4-7/8 4-1/8 x 5-1/8 4-1/4 x 5-1/8 3 x 4 3-1/2 x 4-1/2 4 x 5 4 x 6 4-1/8 4-1/4	1/4 9/32 3/8 5/16 5/16 5/16 5/16 3/8 3/8

THERMICULITE 835 HEAT TREATED INCONEL X-750 SPIRAL WOUND GASKET

**INCREASED SAFETY. PROVEN RESULTS.
PROVEN COST SAVINGS.**

Severe cyclic conditions? For the most demanding cyclic conditions, the choice is Flexitallic's Thermiculite 835 Spiral Wound Gasket with Heat Treated Inconel X-750 winding.

Differential thermal expansion and contraction of components in a bolted joint, due to the effects of cyclic conditions, requires that extra resiliency be built into the joint or the gasket to compensate for fluctuating load conditions.

Normal gasket materials do not provide sufficient resiliency, and therefore cannot compensate for the adverse effects of cyclic conditions. Special Heat Treated Inconel X-750 gasket materials have been developed by Flexitallic to ensure that joint integrity is maintained during thermal cycles.

In OEM and End User testing comparing the performance of standard 316L SS windings vs. Heat Treated Inconel X-750 windings (precipitation hardened), HT Inconel X-750 winding material significantly increased the yield strength resulting in increased springback before leakage, or usable recovery.



Thermiculite 835 Spiral Wound Gasket with Heat Treated Inconel X-750 Winding

Full Scale Test Results (averaged) Gasket Dimensions 40-5/8" x 42" x .175"		
Winding Material	316L SS	Heat Treated Inconel X-750
Initial Thickness	0.178"	0.179"
Compressed Thickness	0.122"	0.121"
Total Springback	0.011"	0.013"
Springback to Leakage @ 2500 psi Test Pressure	0.0038"	0.0078"

Specify Flexitallic's proprietary precipitation hardened Inconel X-750 windings in applications where there are concerns about:

- Cyclic conditions
- Differential thermal expansion and contraction
- Radial shear
- Bolt relaxation
- Hot torquing
- Mating flanges of dissimilar metals

When ordering this material it is important that you specify PRECIPITATION HARDENED INCONEL X750 WINDINGS, OR INCONEL X750HT.



Ethylene Cracker Unit

YOUR GLOBAL GASKET PROVIDER



MULTI-CLASS SPIRAL WOUND GASKET

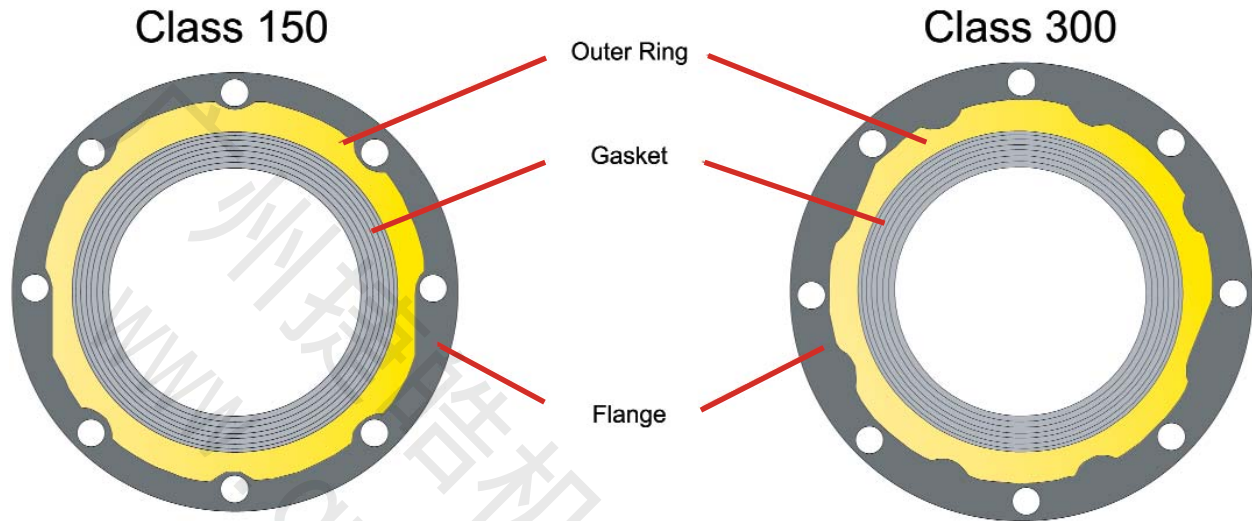

- One gasket accommodates both Class 150 and 300 flanges (Class 150 to 600 in NPS 1/2 through NPS 3)
- Reduces inventory requirements
- Easy to install... Less than half the studs
- Multiple metal windings & fillers available
- Also available with inner rings

THE BAKER* GASKET FOR HF ACID & OTHER HAZARDOUS CHEMICAL APPLICATIONS

Problem

A leak occurs on HF service

- HF can attack the bolts causing bolt failure.
- A small emission goes undetected.

Solution

- Prevents HF attacking the bolts.
- Early detection of small leaks.
- Containment of HF emissions.
- Improves maintenance (detect & repair).
- Requires no modification to the flanges.
- Designed to suit Class 150 & 300 flanges.
- Contains no respirable fibers.

What are the benefits?

The Baker gasket offers the user the reliability of a spiral wound gasket with the additional back-up of an emissions containment system should a leak occur. Reduced maintenance costs through an improved 'Detect & Repair' program. Improvements in plant operators Health & Safety profile.

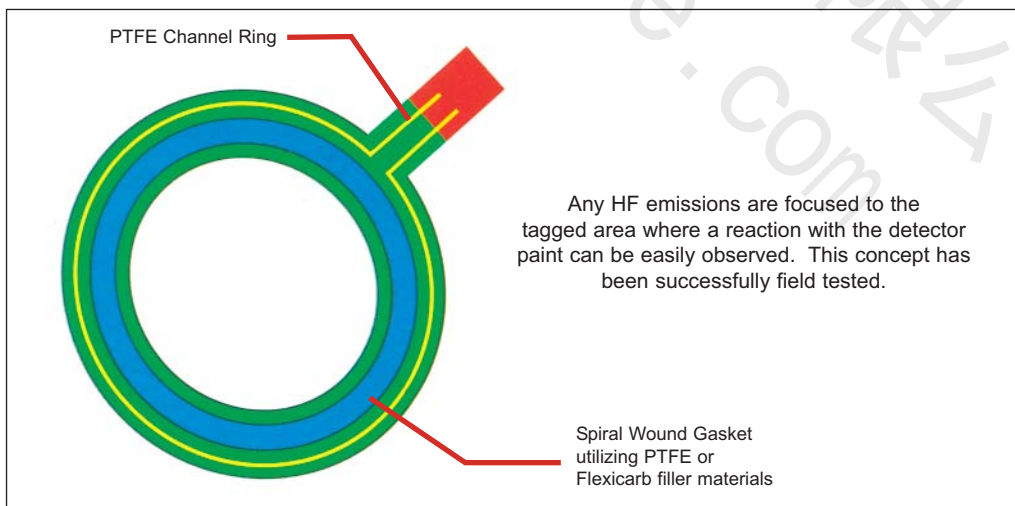
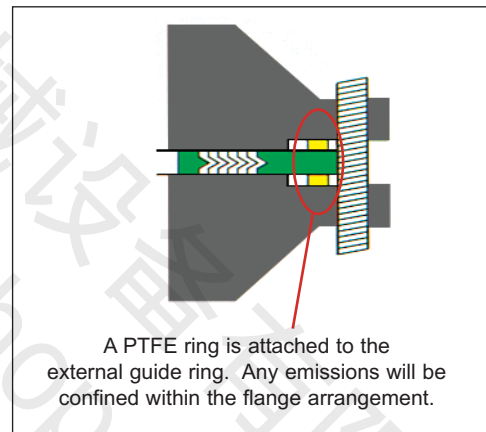
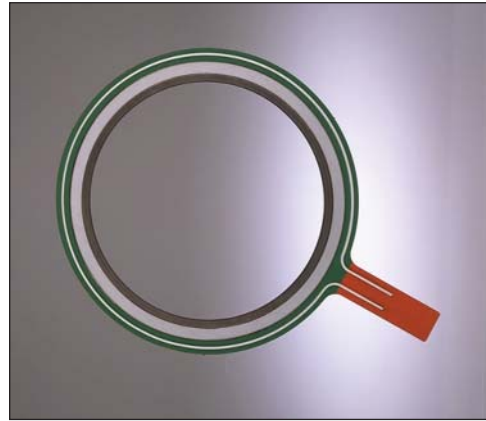

*Patent Pending

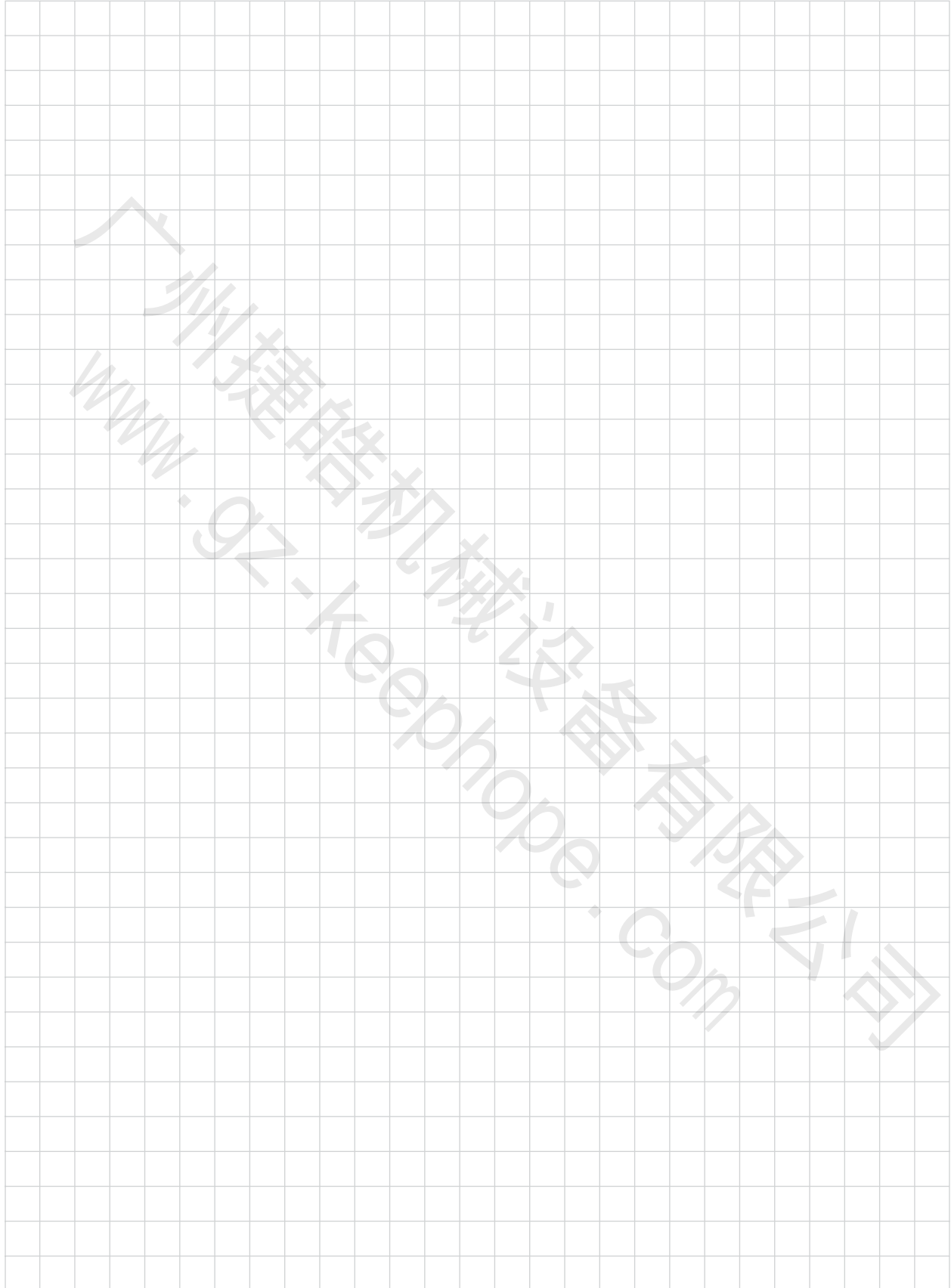

YOUR GLOBAL GASKET PROVIDER



The Flexitallic Group Product Review

Available as part of Flexitallic's standard product offer:

Semi-metallic Gaskets

- Spiral Wound gaskets to international standards
- Thermiculite
- LS & LSI, Low Stress Gaskets
- Heat Exchanger gaskets
- Baker gasket for severe services in the chemical industry
- Flexpro for arduous chemical environments and heat exchangers
- Controlled compression high spec seals to counteract flange rotation
- Carrier Ring gaskets - tandem seals

Sheet Gasket Materials

- SIGMA, biaxially oriented PTFE, offers outstanding chemical resistance
- Thermiculite for High Temperature Applications
- SF and AF asbestos-free alternatives
- Flexicarb, flexible graphite, metal reinforced and homogenous
- Fluoroseal joint sealing tape
- Thread seal tape

Metallic Gaskets

- All Ring Joint gaskets are manufactured to API 6A PSL 4 and ASME B16.20 standards and can be to NACE specification if required
- Blowout preventor gaskets with or without inserts for subsea and wellhead equipment
- Wide variety of metallic seals to customers' design and specification, e.g. CX and AX Ring Joint gaskets

Pump and Valve Seals

- Environflex - a range of low emission valve stem sealing systems designed to meet environmental regulations
- Flexitallic Packings - a comprehensive range of fiber-base packings suitable for pumps, valves and static seals

Service Review

- Full technical information and support
- Design services available
- Global resources with local delivery
- Specialized teams of troubleshooters available

The logo for Flexitallic, featuring the word "Flexitallic" in a stylized, blue, cursive font with a registered trademark symbol.

is a registered Trade Mark of The Flexitallic Group

The data contained in this brochure has been compiled from results of in-house and external testing and customer field reports. While every effort has been taken to ensure the integrity of this data, the company cannot take responsibility for misapplication. The properties of the application shown are typical, Flexitallic therefore recommends that the assistance of the Technical Department is sought when specifying products for new applications. Failure to select a suitable sealing product could result in property damage and/or serious personal injury. As the company's products are used for a multiplicity of purposes, and as Flexitallic has no control over the method of their application or use, Flexitallic excludes and disclaims all warranties, express or implied, as to their products and/or their fitness for a particular purpose.

Flexitallic L.P.
6915 Highway 225
Deer Park, TX 77536 USA
Tel: 281 604 2400

Flexitallic Ltd.
PO Box 3, Marsh Works
Dewsbury Road, Cleckheaton
West Yorkshire, BD19 5BT
England
Tel: 44 1274 851273

Flexitallic Sealing Technology
(Suzhou) Co., Ltd.
Building 3
South 688 Pangjin Road
Wujiang Export Processing Zone
Wujiang, Jiangsu
P.R. China 215200
Tel: 86 512 6303 2839

<http://www.flexitallic.com>

Flexitallic®

DISTRIBUTOR